



ABSORBED GLASS MAT
TECHNOLOGY **AGM**

Manufactured by:

Made in U.S.A.

EAST PENN manufacturing co., inc. Lyon Station, PA 19536



POWER SPORTS BATTERY APPLICATION AND SPECIFICATION GUIDE

*Your complete reference to selecting the proper
replacement battery for ATVs, Motorcycles,
Personal Watercraft & Snowmobiles*

**California
Proposition 65
Warning:**

Batteries, battery posts, terminals and related accessories contain lead and lead compounds, and other chemicals known to the State of California to cause cancer and birth defects or other reproductive harm. **Wash hands after handling!**

TABLE OF CONTENTS

How To Use This Guide	1
Understanding Battery Replacement Options	1
Designation of Battery Type Numbers	1
Safety First: Safe Battery Installation, Charging and Acid Handling	2-3
Battery Specification Data	
Battery Option Chart	4
Competitive Cross Reference	5-6
Terminal Identification	7
Premium AGM Activated Ready-To-Install 12 Volt Battery Specifications	8
Standard AGM Activated Ready-To-Install 12 Volt Battery Specifications	8
Standard AGM – 12 Volt Battery Specifications	8-9
Low Maintenance / High Performance Dry Option 1 – 12 Volt Battery Specifications	9-10
Conventional Dry – 12 Volt Battery Specifications	11
Conventional Dry – 6 Volt Battery Specifications	11-12
12 Volt Import Specialty Battery Specification Data	50
Battery Applications	
Motorcycle	13-25
European Motorcycle	26-32
All Terrain Vehicle	33-36
Personal Watercraft	37-38
Snowmobile	39-44
Scooter	45-46
Utility Vehicle	47
Riding Mower	48-49
Japanese Tractors	50
Recycling	Inside Back Cover

DISCLAIMER STATEMENT: The instructions are based on sound engineering principles, research, extensive field experience, and technical judgements of industry members, and are subject to change in light of developments in technology, field experience, and incoming fit data. The producer of this catalog disclaims any representation or warranty, express or implied, concerning the data or recommendations contained herein, and in no event shall be liable for any loss or damage claimed to have arisen as a result of the use of data or from following the recommendation set forth in this catalog.

HOW TO USE THIS GUIDE

Step 1: Find the model, CC and year of your vehicle in the **Battery Application Section**.

Step 2: Select your battery replacement part number from the options (standard or premium) listed.

CC	MODEL	YEAR	PREMIUM AGM		DRY w/ ACID PART NUMBERS		
			ADAPTER REQ.	PART NUMBER	STANDARD AGM	LOW MAINTENANCE HIGH PERFORMANCE OPTION 1	CONVENTIONAL OPTION 2
HONDA							
1200cc	GL1200 Gold Wing	'84-'87	—	ETX18L	YIX50L-BS	Y50-N18L-A-LM	Y50-N18L-A
1100cc	CB1100F Super Sport	'83	—	ETX15L	—	YB14L-A2	—
	CBR1100XX	'01-'03	—	—	Y12Z12S	—	—
	CBR1100XX Super Sport	'97-'00	—	ETX12	YTX12-BS	—	—
	GL1100 Gold Wing	'80-'83	—	ETX18L	YIX50L-BS	Y50-N18L-A-LM	Y50-N18L-A

Step 3: Find details regarding your battery replacement option in the **Battery Specification Section**.

PART NUMBER	FOOT-NOTES	Ah CAP. @ 10HR.	MAX. OVERALL DIMENSIONS (in)			MAX. OVERALL DIMENSIONS (mm)			ASSEMBLY FIGURE	APPR. DRY WT.		APPR. ACID liters	CCA	
			L	W	H	L	W	H		lbs	kg			
PREMIUM AGM – 12 VOLT														
ETX15	5	14	5 ¼	3 ½	6 ⅞*	134	90	166*			11.0	5.0	N/A	190
ETX15L		14	5 ¼	3 ½	6 ⅞	134	90	166			11.0	5.0	N/A	190
ETX16	3, 6	19	6 ⅞	4	6 ⅞*	175	100	155*			17.0	7.7	N/A	275

UNDERSTANDING BATTERY REPLACEMENT OPTIONS

Premium AGM	The Premium AGM is our highest quality battery. It requires no activation or maintenance and provides greater starting power and service life than the standard AGM and original equipment battery. No vent tube required.
Standard AGM	The Standard AGM features maintenance free power and service life. Activation is required. Acid included. No vent tube required.
High Performance Dry	The equivalent to most vehicle's original equipment battery. It will match required power and maintenance schedule. Activation is required. Supplied with vent tube.
Conventional Dry	Economy battery that requires increased maintenance. Activation is required. Supplied with vent tube.

DESIGNATION OF BATTERY TYPE NUMBERS

Examples:

6	N	2	—	2	A	—	8	Y	50	—	N	18	L	—	A	YB	16	A	L	—	A	2	YT	X	20	L	—	B	S	YT	Z	10	S			
a	b	c	d	e	f	g	h	i	j	k	l	m	n	o	p	q	r	s	t	u	v	w	x	y	z	aa	ab	ac	ad	ae	af	ag	ah	ai	aj	ak



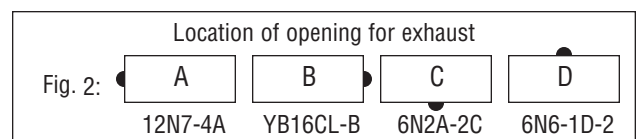
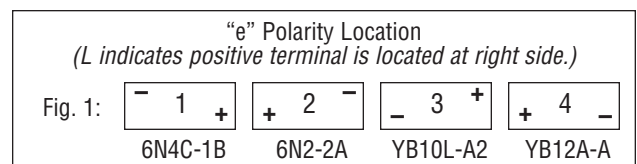

Designations:

- a – nominal voltage
- b – vented type (normal type)
- c – battery capacity at 10 hour rate
- d – indication of different size of the same capacity batteries
- e – polarity location (see Fig. 1), configuration
- f – location of opening for exhaust (see Fig. 2)
- g – type of terminal
- h – symbol of YuMicron batteries
- i – performance level (refer to specifications)
- j – cranking or starting power
- k – symbol of (VRLA) batteries (ET, YT, YI)
- l – sealed, non-spillable
- m – high performance (H, X, Z)



SAFETY FIRST

⚠ DANGER/POISON

 SHIELD EYES. EXPLOSIVE GASES CAN CAUSE BLINDNESS OR INJURY.	 NO • SPARKS • FLAMES • SMOKING	 SULFURIC ACID CAN CAUSE BLINDNESS OR SEVERE BURNS.	 FLUSH EYES IMMEDIATELY WITH WATER.  GET MEDICAL HELP FAST.
---	---	--	--

KEEP OUT OF THE REACH OF CHILDREN.
DO NOT TIP. KEEP VENT CAPS TIGHT AND LEVEL.
DO NOT OPEN FLUSH COVER BATTERIES.

DANGER

EXPLOSIVE GASES

Cigarettes, flames or sparks could cause battery to explode. Always shield eyes and face from battery. Do not charge or use booster cables or adjust post connections without proper instruction and training.

KEEP VENT CAPS TIGHT AND LEVEL.

POISON

CAUSES SEVERE BURNS

Contains sulfuric acid. Avoid contact with skin, eyes or clothing. In event of accident flush with water and call a physician immediately.

KEEP OUT OF REACH OF CHILDREN.

CALIFORNIA PROPOSITION 65 WARNING

Batteries, battery posts, terminals and related accessories contain lead and lead compounds, and other chemicals known to the state of California to cause cancer, birth defects and reproductive harm.

Wash hands after handling.

DANGER OF EXPLODING BATTERIES

Batteries contain sulfuric acid and produce explosive mixtures of hydrogen and oxygen. Because self-discharge action generates hydrogen gas even when the battery is not in operation, make sure batteries are stored and worked on in a well-ventilated area. **ALWAYS wear safety glasses and a face shield** when working on or near batteries. When working with batteries:

- **Always wear proper eye, face and hand protection.**
- Keep all sparks, flames and cigarettes away from the battery.
- Do not attempt to open a flush cover battery.
- **Never lean over battery** while boosting, testing or charging.
- Cover vent caps with a damp cloth to minimize gas seepage.
- Make sure work area is well ventilated.
- **Do not remove or damage vent caps.**

SAFE BATTERY INSTALLATION

To assure safe installation and proper operation, follow these installation procedures:

- **Always wear proper eye, face and hand protection.**
- **Disconnect ground cable first.** (This is usually the negative cable. However, older vehicles may have a positive ground).
- Remove old battery – note position of positive (+) terminal and negative (–) terminal. **Mark the cables for correct connection to new battery.**
- Clean terminals and cable connections with a wire brush. Broken connections or frayed or cut cables should be replaced.
- Install the new battery in the same position as the old one.* **Be sure to secure it with the hold-down assembly.‡**
- Make sure the terminals do not touch any metal mounting, engine or body parts.
- Connect cables tightly. **Connect ground cable last to avoid sparks.**

* Premium AGM batteries are supplied with unique terminal hardware (2 spacers and 2 bolts for cable to terminal connection). This hardware is required for proper installation among various applications. Other hardware may damage terminals and should not be used. The spacers are required for side mount cable installation only! **The top mount terminal position does not require the round spacers, use supplied bolts only!**

‡ ETX14, ETX15, ETX16, and ETX16L batteries may require included height adapter(s) for secure installation into the vehicle. If the adapter is not needed, discard.

Installation of height adapter(s): Remove adapter(s) from top of battery, flip adapter over (tabs facing up) and install on the bottom of battery. Battery should fit securely between tabs. Installation of an adapter will raise the height of the battery allowing use of the vehicle's original hold-down. Be sure the battery is securely anchored in the battery tray. If not, modifications to the vehicle's hold-down may be necessary.

SAFETY FIRST

SAFE CHARGING

Before beginning the charging operation, read and follow the instructions that come with the charger. **Never attempt to charge a battery without first reviewing the instructions for the charger being used.** In addition to the charger manufacturer's instructions, these general precautions should be followed:

- Always charge batteries in a well-ventilated area and **wear proper eye protection.**
- Turn the charger and timer "OFF" before connecting the leads to the battery **to avoid dangerous sparks.**
- To avoid an explosion, never try to charge a visibly damaged or frozen battery.
- Connect the charger leads to the battery; red positive (+) lead to the positive (+) terminal and black negative (-) lead to the negative (-) terminal. If the battery is still in the vehicle, connect the negative lead to the engine block, away from the battery, to serve as a ground. (If the vehicle is positive grounded, connect the positive lead to the engine block.)
- Make sure that the leads to the connections are tight.
- Set the timer, turn the charger on and slowly increase the charging rate until the desired ampere value is reached.
- If the battery becomes hot or if violent gassing or spewing of electrolyte occurs, reduce the charging rate or temporarily halt the charger.
- Always turn the charger "OFF" before removing charger leads from the battery **to avoid dangerous sparks.**

PREMIUM AGM CHARGING

The Premium AGM Power Sports Battery Line is a sealed valve regulated design. Proper charging is important since overcharging and undercharging will damage the product. **We recommend the use of a voltage regulated charger having on-charge voltage, at room temperature, at or between 14.4 to 14.6 volts at 68°F (20°C).** The only way to determine state of charge of your Power Sports Battery is with a voltmeter. The chart at right shows the relationship of stabilized voltage to state of charge.

OPEN CIRCUIT VOLTAGE AS IT RELATES TO STATE OF CHARGE.	
Open Circuit Voltage*	State of Charge
12.70 or greater	100%
12.60	75%
12.30	50%
12.00	25%
11.80	0%

* The actual stabilized OCV can only be determined after the battery has been removed from the charger for 24 hours.

HANDLING BATTERY ACID

Battery acid, or electrolyte, is a solution of sulfuric acid and water that can destroy clothing and burn the skin. Use extreme caution when handling electrolyte and keep an acid neutralizing solution - such as baking soda or household ammonia mixed with water - readily available. When handling batteries:

- **Always wear proper eye, face and hand protection.**
- If the electrolyte is splashed into an eye, immediately force the eye open and flood it with clean, cool water for at least 15 minutes. Get prompt medical attention.
- If electrolyte is taken internally, drink large quantities of water or milk. **DO NOT** induce vomiting. Call a physician immediately.
- Neutralize with baking soda any electrolyte that spills on a vehicle or in the work area. After neutralizing, rinse contaminated area clean with water.

Mixing acid can be very dangerous! Do not attempt without proper training. To prepare electrolyte of a specific gravity, always pour the concentrated acid slowly into the water; **DO NOT pour water into the acid.** Always stir the water while adding small amounts of acid. If noticeable heat develops, allow the solution to cool before continuing to add acid.

Source: Battery Council International

BATTERY OPTION CHART

BATTERY SPECS.

ACTIVATED READY TO INSTALL	DRY / ACTIVATION REQUIRED		
PREMIUM AGM	STANDARD AGM	HIGH PERFORMANCE	CONVENTIONAL
ETX9	YTX9-BS	—	—
ETX12	YTX12-BS	—	—
ETX12 {56}	YTX12-BS {56}	YB12B-B2	—
ETX14 {77}	YTX14-BS	—	—
ETX14 {56,64,67}	—	YB16B-A	—
ETX14 {56, 67}	—	YB16B-A1	—
ETX14 {64, 67}	YTX16-BS-1	—	—
ETX14 {67}	YTX16-BS	—	—
ETX15 {76}	YTX14AH-BS	—	—
ETX15 {76}	—	YB14-A2	—
ETX15 {76}	—	YB14-B2	—
ETX15 {76}	—	YB14A-A1	—
ETX15 {76}	—	YB14A-A2	—
ETX15L	YTX14AHL-BS	—	—
ETX15L	—	YB14L-A2	12N14-3A
ETX15L	—	YB14L-B2	—
ETX15L {55}	—	SYB14L-A2 {65}	—
ETX15L {55}	—	SYB14L-B2 {65}	—
ETX15L {64}	—	YB14L-A1	—
ETX16 {77}	—	YB16-B-LM (CX)	—
ETX16 {77}	YTX20-BS {66}	YB16-B (LM)	—
ETX16 {56, 67}	—	Y60-N24-A	—
ETX16 {67}	—	YB16C-B	—
ETX16L {74,77}	YTX20L-BS {66}	YB16HL-A-LM (CX)	—
ETX16L {74,77}	YTX20L-BS {66}	YB16L-B	12N16-3B
ETX16L {55}	—	SYB16L-B {65}	—
ETX16L {120}	—	—	12N24-3
ETX16L {120}	—	—	12N24-3A
ETX16L {120}	—	Y60-N24-AL-B	—
ETX16L {67}	—	YB16CL-B	—
ETX18L {77}	YTX24HL-BS	—	—
ETX18L {77}	—	Y50-N18L-A3	—
ETX18L {77}	YTX24HL-BS	Y50-N18L-A3	—
ETX18L {55,64}	—	SY50-N18L-AT {65}	—
ETX18L {55,64}	YTX24HL-BS {55,64}	SY50-N18L-AT {65}	—
ETX18L {117}	—	Y50-N18A-A	—
ETX18L {117}	YTX24HL-BS {117}	Y50-N18A-A	—
ETX18L {64}	—	Y50-N18L-A(LM,CX)	—
ETX18L {64}	YTX24HL-BS {64}	Y50-N18L-A(LM,CX)	—
ETX20L {77}	YTX20L-BS	—	—
ETX20L {77}	YTX20HL-BS	—	—
ETX20L {56}	YTX20L-BS {66}	YB18L-A {56}	—
ETX30L {77}	YIX30L	YB30L-B	—
ETX30LA	—	YB30CL-B	—
—	YTX20-BS {66}	YB18-A	—
—	—	6YB11-2D	6N11-2D
—	—	YB5L-B	12N5-3B
—	—	YB7-A	12N7-4A
—	—	YB7L-B	12N7-3B
—	—	YB9-B	12N9-4B-1
—	—	YB9L-A2	12N9-3A-1
—	—	YB9L-B	12N9-3B
—	—	YB10L-A2	12N10-3A-2
—	—	YB10L-B	12N10-3B
—	—	YB12A-A	12N12A-4A-1

{55} Sensor not included with replacement battery. Disconnect sensor.

{56} Hold down modification may be necessary.

{64} Top and front terminal mounts only.

{65} Includes sensor not supplied with AGM.

{66} The YTX20 series batteries may be used as an optional upgrade, but some modification to the hold-down may be necessary. See battery label for retrofit cautions.

{67} Supplied adapter may be required for proper fit.

{74} Shipped with 20mm adapter.

{76} Shipped with 10mm adapter.

{77} Does not meet Harley-Davidson OEM specifications.

{117} Battery must be rotated for correct polarity. Hold-down modifications may be necessary. Top and front terminal mounts only.

{120} Shipped with 20mm adapter. Hold-down modifications may be necessary.

Note: Yuasa part numbers sometimes end in CX vs. LM.

COMPETITIVE CROSS REFERENCE

BATTERY SPECS.

DEKA	MAGNA POWER	YUASA	GNB	DELCO	INTERSTATE	GS-JSB	NAPA	SEARS	WAL-MART
PREMIUM SEALED MAINTENANCE FREE									
YTX4L-BS	GT4L-BSFP	YTX4L-BS	4L-BS	GT4L-BS	YTX4L-BS	---	740-1865	44015	ES4LBS
YTX5L-BS	GTX5LBSFP	YTX5L-BS	5L-BS	GTX5L-BS	YTX5L-BS	---	---	44022	---
YTX7A-BS	---	YTX7A-BS	7A-BS	---	YTX7A-BS	---	---	44023	---
YTX7L-BS	---	YTX7L-BS	7L-BS	---	YTX7L-BS	GTX7L-BS	---	44024	---
ETX9	ETX9	YTX9-BS	9-BS	GTX9-BS	YTX9-BS	---	740-1825	44025	---
YTX9-BS	GTX9-BSFP	YTX9-BS	---	---	---	---	---	---	---
ETX12	ETX12	YTX12-BS	12-BS	GTX12-BS	YTX12-BS	---	740-1866	44016	ES12BS
YTX12-BS	GTX12-BSFP	YTX12-BS	---	---	---	---	---	---	---
ETX14	ETX14	YTX14-BS	14-BS	GTX14-BS	YTX14-BS	---	740-1886	44017	ES14BS
YTX14-BS	GTX14-BSFP	YTX14-BS	---	---	---	---	---	---	---
YTX16-BS	---	YTX16-BS	---	---	---	---	---	---	---
YTX16-BS-1	---	YTX16-BS-1	---	---	---	---	---	---	---
YTX14L-BS	---	YTX14L-BS	---	---	YTX14L-BS	---	---	---	---
ETX15	ETX15	YTX14AH-BS	---	GTX14AH-BS	YTX14AH-BS	---	---	44004	---
YTX14AH-BS	ETX15	YTX14AH-BS	---	---	---	---	---	---	---
ETX15L	ETX15L	YTX14AHL-BS	---	GTX14AHL-BS	YTX14AHL-BS	---	---	44005	---
YTX14AHL-BS	ETX15L	YTX14AHL-BS	---	---	---	---	---	---	---
YTX15L-BS	---	YTX15L-BS	---	---	YTX15L-BS	---	---	44162	---
ETX16	ETX16	YTX20-BS	16-BS	---	YTX20-BS	---	TBA	44028	---
YTX20-BS	ETX16	YTX20-BS	---	---	---	---	---	---	---
ETX16L	ETX16L	YTX20L-BS	16L-BS	GTX20L-BS (66)	YTX20L-BS (66)	---	TBA	44027	---
YTX20L-BS	ETX16L	YTX20L-BS	---	---	---	---	---	---	---
ETX18L	ETX18L	YTX24HL-BS	18L-BS	GTX24HL-BS	YTX24HL-BS	---	TBA	44006	---
YTX24HL-BS	ETX18L	YTX24HL-BS	---	---	---	---	---	---	---
ETX20L	ETX20L	YTX20L-BS	20L-BS	GTX20L-BS	YTX20L-BS	---	TBA	44027	---
YTX20L-BS	GTX20L-BSFP	YTX20L-BS	---	---	---	---	---	---	---
ETX20L	ETX20L	YTX20HL-BS	---	GTX20HL-BS	YTX20HL-BS	---	---	---	---
YTX20HL-BS	GTX20L-BSFP	YTX20HL-BS	---	---	---	---	---	---	---
ETX30L	YIX30L	YIX30L	---	---	YIX30L	YGIX30	---	---	---
PREMIUM									
YB2.5L-C	---	YB2.5L-C	2.5L-C	---	Y2.5L-C	GM2.5A-3C-3	---	44035	---
YB2.5L-C-1	---	YB2.5L-C-1	2.5L-C-1	---	YB2.5L-C-1	GM2.5A-3C-1	---	44036	---
YB3L-A	---	YB3L-A	3L-A	---	YB3L-A	GM3-3A	---	44037	---
YB3L-B	---	YB3L-B	3L-B	---	YB3L-B	GM3-3B	---	44038	---
YB4L-A	---	YB4L-A	4L-A	---	YB4L-A	GM4A-3B	---	44039	---
YB4L-B	CB4L-BFP	YB4L-B	4L-B	MC0414	YB4L-B	GM4-3B	740-1861	44014	---
YB5L-B	CB5L-BFP	YB5L-B	5L-B	---	YB5L-B	GM5Z-3B	740-1868	44353	---
YB7-A	---	YB7-A	7-A	---	YB7-A	GM7Z-4A	---	44040	---
YB7C-A	---	YB7C-A	7C-A	---	YB7C-A	GM7CZ-3D	M227CY	44041	---
YB7L-B	---	YB7L-B	7L-B	---	YB7L-B	GM7-3B-1	---	44042	---
YB9A-A	CB9A-AFP	YB9A-A	9AA	CB9A-A	YB9A-A	GM9AZ-4A	740-1872	44043	---
YB9L-A2	---	YB9L-A2	9L-A2	---	YB9L-A2	---	---	44044	---
YB9-B	CB9-BFP	YB9-B	9-B	---	YB9-B	GM9Z-4B	740-1858	44356	---
YB9L-B	CB9L-BFP	YB9L-B	9LB	---	YB9L-B	GM9Z-3B	740-1837	44045	---
YB10A-A2	---	YB10A-A2	10A-A	---	YB10A-A2	---	---	44046	---
YB10L-A2	CB10L-A2FP	YB10L-A2	10LA2	MC1114	YB10L-A2	GM10Z-3A	740-1857	44355	ES10LA2
YB10L-B	---	YB10L-B	10L-B	---	YB10L-B	GM10-3B	740-1831	44047	---
YB10L-B2	---	YB10L-B2	10L-B2	---	YB10L-B2	---	740-1832	44048	---
YB12A-A	CB12A-AFP	YB12A-A	12AA	MC1216	YB12A-A	GM12AZ-4A-1	740-1854	44358	ES12AA
YB12AL-A	CB12AL-AFP	YB12AL-A	12AL-A	---	YB12AL-A	GM12AZ-3A-1	740-1873	44052	---
YB12A-B	---	YB12A-B	12A-B	---	YB12A-B	---	---	44053	---
YB12B-B2	---	YB12B-B2	12B-B2	---	YB12B-B2	GM12B-4B	---	44054	---
YB12C-A	---	YB12C-A	12C-A	---	YC12C-A	GM12CZ-4A-2	---	44055	---
YB14-A2	CB14-A2FP	YB14-A2	14-A2	---	YB14-A2	GM14Z-4A	740-1864	44363	---
YB14A-A1	CB14A-AFP	YB14A-A1	14AA1	---	YB14A-A1	GM14AZ-4A	740-1826	44056	---
YB14A-A2	CB14A-A2FP	YB14A-A2	14AA2	MC1418	YB14A-A2	GM14AZ-4A-1	740-1860	---	ES14AA2
YB14L-A1	---	YB14L-A1	14L-A1	---	YB14L-A1	GM14Z-3A-1	---	44057	---
---	---	YMF14L-2 *	14L-2	---	---	---	---	---	---
YB14L-A2	CB14L-A2FP	YB14L-A2	14L-A2	MC1406	YB14L-A2	GM14Z-3A	740-1851	44364	ES14L-A2
YB14L-B2	---	YB14L-B2	14L-B2	---	YB14L-B2	GM14Z-3B	740-1828	44059	---
---	---	YB14-B2	14-B2	---	YB14-B2	---	---	44060	---
SYB14L-A2	---	SYB14L-A2	14LA2	---	SYB14L-A2	---	---	44061	---

See page 6 for footnote explanations.

COMPETITIVE CROSS REFERENCE

BATTERY SPECS.

DEKA	MAGNA POWER	YUASA	GNB	DELCO	INTERSTATE	GS-JSB	NAPA	SEARS	WAL-MART
PREMIUM (continued)									
SYB14L-B2	—	SYB14L-B2	14-LB2	—	SYB14L-B2	—	—	44062	—
YB16AL-A2	CB16AL-A2FP	YB16AL-A2	16ALA2	CB16AL-A2	YB16AL-A2	GM16A-3A	740-1877	44063	—
HYB16A-AB	HCB16A-AFP	HYB16A-AB	16AA	—	HYB16A-AB	GM16-T	740-1867	44064	—
YB16-B	CB16-BFP	YB16-B	16B	MC1912	YB16-B	GM16Z-4BH	740-1852	44366	ES16B
YB16L-B	CB16L-BFP	YB16L-B	16LB	—	YB16L-B	GM16Z-3B	740-1827	44065	—
16-B-LM	—	YB16-B-CX	16-B-LM	—	YB16-B-LM	—	—	44029	—
16HL-A-LM	—	YB16HL-A-CX	16HL-A-LM	—	YB16HL-A-LM	—	—	—	—
YB16B-A	—	YB16B-A	16B-A	—	YB16B-A	GM16B-4A	—	44066	—
YB16B-A1	—	YB16B-A1	16B-A1	—	YB16B-A1	—	—	44067	—
YB16C-B	—	YB16C-B	16C-B	—	YB16C-B	—	—	44068	—
YB16CL-B	CB16CL-BFP	YB16CL-B	16CLB	M1924	YB16CL-B	GM16AZ-3B	740-1862	44001	ES16CLB
—	—	SYB16L-B	16L-B	—	SYB16L-B	—	—	44069	—
YB18-A	CB18-AFP	YB18-A	18-A	—	YB18-A	GM18A-4A	740-1874	44070	—
YB18L-A	CB18L-AFP	YB18L-A	18LA	—	YB18L-A	GM18A-3A	740-1871	44071	—
Y50-N18A-A	—	Y50-N18A-A	50-N18A-A	—	Y50-N18A-A	—	—	44072	—
Y50-N18L-A	—	Y50-N18L-A	50N18LA2	MC2008	Y50-N18L-A	GM18Z-3A(S)	—	—	ES50N-N18L-A
Y50-N18L-A3	C50N18L-A3FP	Y50-N18L-A3	50N18LA3 **	—	Y50-N18L-A3	—	740-1855	44359	—
—	—	Y60-N24-A	60-N24-A	—	Y60-N24-A	—	—	44074	—
Y60-N24AL-B	—	Y60-N24AL-B	60-N24AL-B	—	Y60-N24AL-B	—	740-1880	44075	—

FOOTNOTES:

- * - Superseded by YTX14AHL-BS.
- ** - GNB's 50N18LA3 replaces 50N18LA2.
- *** - Discontinued battery when stock depleted.

BATTERY SPECIFICATION DATA

BATTERY SPECS.

TERMINALS

Terminal shapes vary from one battery to another. By identifying the correct replacement battery from the listing in this book, you are assured of the proper terminal configuration. For custom applications, refer to the following chart to identify terminal shape and corresponding batteries.

Terminal Shape				Battery Type				
Type	Front	Side	Top					
1				YB14L-A1 YTX16-BS-1				
2				YB9L-A2 12N5.5-4A	YB16AL-A2			
3				YB7C-A 12N24-3	YB7L-B	Y60-N24AL-B	Y60-N24-A	
4				YB12C-A YTX14L-BS YTX20CH-BS YTX20HL-PW	YB16B-A YTX14AH-BS YTX20-BS YTX24HL	Y50-N18L-A3 YTX14AHL-BS YTX20L-BS YTX24HL-BS	YB30L-B YTX15L-BS YTX20H-BS YTX20HL-BS-PW	YB30CL-B YTX16-BS YTX20HL-BS
5				YTX4L-BS YTX9-BS YB4L-A	YTX5L-BS YTX12-BS YB4L-B	YTZ7S KMX14-BS YB16C-B	YTX7A-BS YTX14-BS YB16CL-B	YTX7L-BS YIX30L
6				YB3L-A YB9-B YB12A-B YB16HL-A-LM 12N5-3B 12N7-4A 12N9-4B-1 12N16-3B 6N6-3B B39-6	YB5L-B YB9L-B YB14A-A1 SYB16L-B 12N5-4B 12N7-4B 12N10-3A 6N6-3B-1 B54-6	YB7-A YB10L-B YB16-B 12N5.5-3B 12N7D-3B 12N10-3A-1 6N11A-1B B38-6A	YB7B-B YB12A-A YB16-B-LM 12N5.5A-3B 12N9-3A-1 12N10-3B 6N11-2D	YB9A-A YB12AL-A YB16L-B 12N7-3B 12N9-3B 12N12A-4A-1 6N12A-2D
7				HYB16A-AB Y50-N18A-A	YB16B-A Y50-N18L-A	YB18-A Y50-N18L-A-LM	YB18L-A SY50-N18L-AT	
8				YB10A-A2 YB12B-B2 SYB14L-A2 12N10-3A-2	YB10L-A2 YB14-A2 YB14-B2 12N11-3A-1	YB10L-B2 YB14A-A2 YB14L-B2 12N14-3A	YB12AL-A2 YB14L-A2	
9				YHD-12	12N9-3A			
10				51814	51913	53030		
11				YT9B-4 YT7B-BS	YTZ10S YTR9-BS	YTZ12S YT12A-BS	YTZ14S YT12B-BS	YT14B-4
12				YTR4A-BS				
13				YT4B-BS				
14				ETX9 ETX16 ETX30LA	ETX12 ETX16L	ETX14 ETX18L	ETX15 ETX20L	ETX15L ETX30L

BATTERY SPECIFICATION DATA

BATTERY SPECS.

PART NO.	CAP. AH (10 HR)	DIMENSIONS (in.) (± 1/16 in.)			DIMENSIONS (mm) (± 2 mm)			ASSEMBLY FIGURE (AS PER COVER POLARITY)	WEIGHT W/O ACID (lbs.)	TERM. TYPE (SEE PG. 6)	ACID VOLUME (LITER)	REG. CHARGE CURRENT (AMP)	CCA @ 0°F (-18°C)
		L	W	H	L	W	H						
PREMIUM AGM ACTIVATED — READY-TO-INSTALL — 12 VOLT													
ETX9	8	5½	3⅞	4⅜	150	88	106		6.3	14	N/A	1.5	120
ETX12	10	5½	3⅞	5½	150	88	130		9.4	14	N/A	2.0	180
ETX14 {75, 77}	12	5½	3⅞	5½ #	150	88	145 #		12.0	14	N/A	3.0	200
ETX15 {76}	14	5¼	3½	6⅞ #	134	90	166 #		11.0	14	N/A	3.0	190
ETX15L	14	5¼	3½	6⅞	134	90	166		11.0	14	N/A	3.0	190
ETX16 {74, 77}	19	6½	4	6⅞ #	175	100	155 #		17.0	14	N/A	4.0	275
ETX16L {74, 77}	19	6½	4	6⅞ #	175	100	155 #		17.0	14	N/A	4.0	275
ETX18L {77}	20	8½	3⅞	6⅞	206	91	163		18.0	14	N/A	5.0	300
ETX20L {77}	17.5	6½	3⅞	6⅞	177	88	155		15.5	14	N/A	4.0	270
ETX30L {77}	26	6½	5⅞	6⅞	168	131	176		21.7	14	N/A	6.0	365
ETX30LA	26	6½	5⅞	7¼	168	131	192.2		21.7	14	N/A	6.0	365
STANDARD AGM ACTIVATED — READY-TO-INSTALL — 12 VOLT													
YTZ7S	6	4⅞	2¼	4¼	113	70	105		4.6	5	N/A	0.6	130
YT9B-4	8	6	2¼	4¼	150	70	105		7.5	11	N/A	0.8	115
YTZ10S	8.6	6	3⅞	3⅞	150	87	93		7.0	11	N/A	0.9	190
YTZ12S	11	6	3⅞	4¼	150	87	110		8.1	11	N/A	1.1	210
YTZ14S	11.2	6	3⅞	4¼	150	87	110		8.6	11	N/A	1.1	230
YT14B-4	12	6	2¼	5¼	150	70	145		10.1	11	N/A	1.2	135
YIX30L	30	6⅞	5	6⅞	166	126	175		22.0	5	N/A	2.8	385
STANDARD AGM — 12 VOLT													
YTR4A-BS	2.3	4½	1⅞	3⅞	114	49	86		2.0	13	0.14	0.3	45
YT4B-BS	2.3	4½	1⅞	3⅞	114	39	86.5		2.1	13	0.12	0.3	40
YTX4L-BS	3	4½	2⅞	3⅞	114	71	86		2.9	5	0.18	0.4	50
YTX5L-BS	4	4½	2⅞	4⅞	114	71	106		3.5	5	0.24	0.5	70
YT7B-BS	6.5	6	2⅞	3⅞	150	65	93		5.0	12	0.33	0.7	85
YTX7A-BS	6	6	3⅞	3¼	150	87	94		5.3	5	0.33	0.7	90
YTX7L-BS	6	4½	2⅞	5⅞	114	71	131		5.1	5	0.33	0.6	85
YTR9-BS	8	6	3⅞	4⅞	150	87	105		5.8	12	0.40	0.9	120
YTX9-BS	8	6	3⅞	4⅞	150	87	105		5.4	5	0.40	0.9	120
YT12A-BS	9.5	6	3⅞	4⅞	150	87	105		6.3	12	0.50	1.0	175
YT12B-BS	10	6	2¼	5½	150	69	130		7.6	12	0.50	1.0	125
YTX12-BS	10	6	3⅞	5 ½	150	87	130		7.5	5	0.60	1.2	180
YTX14AH-BS {72}	12	5⅞	3½	6⅞	134	89	166		7.7	4	0.66	1.2	210
YTX14AHL-BS	12	5⅞	3½	6⅞	134	89	166		7.7	4	0.66	1.2	210
YTX14-BS	12	6	3⅞	5¼	150	87	145		8.1	5	0.70	1.4	200
YTX14L-BS	12	6	3⅞	5¼	150	87	145		8.1	5	0.70	1.4	200
YTX15L-BS	13	6½	3⅞	5½	175	87	130		8.8	4	0.75	1.3	230

See page 12 for footnote explanations.

BATTERY SPECIFICATION DATA

BATTERY SPECS.

PART NO.	CAP. AH (10 HR)	DIMENSIONS (in.) (± 1/16 in.)			DIMENSIONS (mm) (± 2 mm)			ASSEMBLY FIG. (AS PER COVER POLARITY)	WEIGHT W/O ACID (lbs.)	TERM. TYPE (REFER TO PG 6)	ACID VOLUME (LITER)	REG. CHARGE CURRENT (AMP)	CCA @ 0°F (-18°C)
		L	W	H	L	W	H						
STANDARD AGM – 12 VOLT (continued)													
YTX16-BS	14	6	3 ³ / ₁₆	6%	150	87	161		10.3	4	0.78	1.4	230
YTX16-BS-1	14	6	3 ³ / ₁₆	6%	150	87	161		10.3	1	0.78	1.4	230
YTX20-BS (66)	18	6 ¹ / ₂	3 ³ / ₁₆	6%	175	87	155		11.2	4	0.93	1.8	270
YTX20CH-BS	18	6	3 ³ / ₁₆	6%	150	87	161		11.4	4	0.82	1.8	270
YTX20H-BS	18	6 ¹ / ₂	3 ³ / ₁₆	6%	175	87	155		12.4	4	0.93	1.8	310
YTX20HL-BS	18	6 ¹ / ₂	3 ³ / ₁₆	6%	175	87	155		12.4	4	0.93	1.8	310
YTX20HL-BS-PW	18	6 ¹ / ₂	3 ³ / ₁₆	6 ¹ / ₂ {71}	175	87	175 {71}		12.4	4	0.93	1.8	310
YTX20L-BS (66)	18	6 ¹ / ₂	3 ³ / ₁₆	6%	175	87	155		11.2	4	0.93	1.8	270
YTX24HL-BS	21	8 ¹ / ₂	3 ³ / ₁₆	6%	205	87	162		14.4	4	0.99	2.1	350
LOW MAINTENANCE / HIGH PERFORMANCE DRY OPTION 1 – 12 VOLT													
YB2.5L-C	2.5	3 ³ / ₁₆	2 ¹ / ₄	4 ¹ / ₂	80	70	105		1.7	—	8.1	0.3	—
YB2.5L-C-1	2.5	3 ³ / ₁₆	2 ¹ / ₄	4 ¹ / ₂	80	70	105		1.7	—	8.1	0.3	—
YB3L-A	3	3 ³ / ₁₆	2 ¹ / ₄	4 ¹ / ₂	98	56	110		2.5	6	8.1	0.3	—
YB3L-B	3	3 ³ / ₁₆	2 ¹ / ₄	4 ¹ / ₂	98	56	110		2.5	6	8.1	0.3	—
YB4L-A	4	4 ¹ / ₄	2 ¹ / ₄	3 ¹ / ₂	120	70	92		2.8	5	10.1	0.4	—
YB4L-B	4	4 ¹ / ₄	2 ¹ / ₄	3 ¹ / ₂	120	70	92		2.8	5	10.1	0.4	—
YB5L-B	5	4 ¹ / ₄	2 ¹ / ₄	5 ¹ / ₂	120	60	130		3.5	6	12.2	0.5	—
YB7-A	8	5 ⁵ / ₁₆	3	5 ¹ / ₂	135	75	133		5.1	6	20.3	0.8	—
YB7B-B	7	6	2 ¹ / ₄	5 ¹ / ₂	150	60	130		4.0	6	16.9	0.7	—
YB7C-A	8	5 ⁵ / ₁₆	3 ³ / ₁₆	4 ¹ / ₂	130	90	114		5.1	3	20.3	0.8	—
YB7L-B	8	5 ⁵ / ₁₆	3	5 ¹ / ₂	135	75	133		5.1	3	20.3	0.8	—
YB9A-A	9	5 ⁵ / ₁₆	3	6 ¹ / ₂	135	75	155		5.3	6	20.3	0.9	—
YB9L-A2	9	5 ⁵ / ₁₆	3	5 ¹ / ₂	135	75	139		5.3	2	20.3	0.9	—
YB9-B	9	5 ⁵ / ₁₆	3	5 ¹ / ₂	135	75	139		5.3	6	20.3	0.9	—
YB9L-B	9	5 ⁵ / ₁₆	3	5 ¹ / ₂	135	75	139		5.3	6	20.3	0.9	—
YB10A-A2	11	5 ⁵ / ₁₆	3 ³ / ₁₆	6 ¹ / ₂	135	90	155		7.0	8	27.0	1.1	—
YB10L-A2	11	5 ⁵ / ₁₆	3 ³ / ₁₆	5 ¹ / ₂	135	90	145		7.0	8	27.0	1.1	—
YB10L-B	11	5 ⁵ / ₁₆	3 ³ / ₁₆	5 ¹ / ₂	135	90	145		7.0	6	27.0	1.1	—
YB10L-B2	11	5 ⁵ / ₁₆	3 ³ / ₁₆	5 ¹ / ₂	135	90	145		7.0	8	27.0	1.1	—
YB12A-A	12	5 ⁵ / ₁₆	3 ³ / ₁₆	6 ¹ / ₂	134	80	160		6.8	6	27.0	1.2	—
YB12A-A W/S {57}	12	5 ⁵ / ₁₆	3 ³ / ₁₆	6 ¹ / ₂	134	80	160		6.8	6	27.0	1.2	—
YB12A-A W/TA {59}	12	5 ⁵ / ₁₆	3 ³ / ₁₆	6 ¹ / ₂	134	80	160		6.8	6	27.0	1.2	—
YB12AL-A W/TA {59}	12	5 ⁵ / ₁₆	3 ³ / ₁₆	6 ¹ / ₂	134	80	160		6.8	6	25.4	1.2	—
YB12AL-A	12	5 ⁵ / ₁₆	3 ³ / ₁₆	6 ¹ / ₂	134	80	160		6.8	6	25.4	1.2	—
YB12AL-A2	12	5 ⁵ / ₁₆	3 ³ / ₁₆	6 ¹ / ₂	134	80	160		6.8	8	25.4	1.2	—
YB12A-B	12	5 ⁵ / ₁₆	3 ³ / ₁₆	6 ¹ / ₂	134	80	160		6.8	6	25.4	1.2	—

See page 12 for footnote explanations.

BATTERY SPECIFICATION DATA

PART NO.	CAP. AH (10 HR)	DIMENSIONS (in.) (± 1/16 in.)			DIMENSIONS (mm) (± 2 mm)			ASSEMBLY FIG. (AS PER COVER POLARITY)	WEIGHT W/O ACID (lbs.)	TERM. TYPE (REFER TO PG 6)	ACID VOLUME (OUNCES)	REG. CHARGE CURRENT (AMP)	CCA @ 0°F (-18°C)
		L	W	H	L	W	H						
LOW MAINTENANCE / HIGH PERFORMANCE DRY OPTION 1 – 12 VOLT (continued)													
YB12B-B2	12	6 ⁵ / ₁₆	3 ³ / ₁₆	5 ¹ / ₂	160	90	130		7.1	8	27.0	1.2	—
YB12C-A	12	5 ⁵ / ₁₆	3 ³ / ₁₆	6 ¹ / ₂	134	80	175		7.1	4	27.0	1.2	—
YB14-A2	14	5 ⁵ / ₁₆	3 ¹ / ₂	6 ⁵ / ₁₆	134	89	166		7.6	8	30.4	1.4	—
YB14A-A1	14	5 ⁵ / ₁₆	3 ¹ / ₂	6 ⁵ / ₁₆	134	89	176		7.9	6	30.4	1.4	—
YB14A-A2	14	5 ⁵ / ₁₆	3 ¹ / ₂	6 ⁵ / ₁₆	134	89	176		7.9	8	30.4	1.4	—
YB14L-A1	14	5 ⁵ / ₁₆	3 ¹ / ₂	6 ⁵ / ₁₆	134	89	166		7.6	1	30.4	1.4	—
YB14L-A2	14	5 ⁵ / ₁₆	3 ¹ / ₂	6 ⁵ / ₁₆	134	89	166		7.6	8	30.4	1.4	—
YB14L-A2 W/S {57}	14	5 ⁵ / ₁₆	3 ¹ / ₂	6 ⁵ / ₁₆	134	89	166		7.6	8	30.4	1.4	—
YB14L-B2	14	5 ⁵ / ₁₆	3 ¹ / ₂	6 ⁵ / ₁₆	134	89	166		7.6	8	30.4	1.4	—
YB14-B2*	14	5 ⁵ / ₁₆	3 ¹ / ₂	6 ⁵ / ₁₆	134	89	166		7.6	8	30.4	1.4	—
SYB14L-A2 {65}	14	5 ⁵ / ₁₆	3 ¹ / ₂	6 ⁵ / ₁₆	134	89	166		7.6	8	30.4	1.4	—
SYB14L-B2 {65} ^{D3}	14	5 ⁵ / ₁₆	3 ¹ / ₂	6 ⁵ / ₁₆	134	89	166		7.6	8	30.4	1.4	—
YB16AL-A2	16	8 ¹ / ₂	2 ³ / ₁₆	6 ⁵ / ₁₆	207	71.5	164		8.6	2	37.2	1.6	—
HYB16A-AB	16	6	3 ³ / ₁₆	7 ¹ / ₁₆	151	91	180		8.5	7	30.4	1.6	—
YB16-B	19	6 ⁵ / ₁₆	4	6 ⁵ / ₁₆	175	100	155		10.5	6	40.6	1.9	—
YB16-B-LM	19	6 ⁵ / ₁₆	4	6 ⁵ / ₁₆	175	100	155		10.5	6	40.6	1.9	—
YB16L-B	19	6 ⁵ / ₁₆	4	6 ⁵ / ₁₆	175	100	155		10.5	6	40.6	1.9	—
YB16HL-A-LM	19	6 ⁵ / ₁₆	4	6 ⁵ / ₁₆	175	100	155		10.5	6	40.6	1.9	—
YB16B-A	16	6 ⁵ / ₁₆	3 ³ / ₁₆	6 ⁵ / ₁₆	160	90	161		8.4	7	33.8	1.6	—
YB16B-A1	16	6 ⁵ / ₁₆	3 ³ / ₁₆	6 ⁵ / ₁₆	160	90	161		8.4	4	33.8	1.6	—
YB16C-B	19	6 ⁵ / ₁₆	4	6 ⁵ / ₁₆	175	100	175		10.1	5	40.6	1.9	—
YB16CL-B	19	6 ⁵ / ₁₆	4	6 ⁵ / ₁₆	175	100	175		10.1	5	40.6	1.9	—
SYB16L-B {65} ^D	19	6 ⁵ / ₁₆	4	6 ⁵ / ₁₆	175	100	155		9.3	6	43.9	1.9	—
YB18-A	18	7 ¹ / ₂	3 ³ / ₁₆	6 ⁵ / ₁₆	180	90	162		9.4	7	40.6	1.8	—
YB18L-A	18	7 ¹ / ₂	3 ³ / ₁₆	6 ⁵ / ₁₆	180	90	162		9.4	7	40.6	1.8	—
Y50-N18A-A	20	8 ¹ / ₂	3 ³ / ₁₆	6 ⁵ / ₁₆	205	90	176		11.2	7	50.7	2.0	—
Y50-N18L-A	20	8 ¹ / ₂	3 ³ / ₁₆	6 ⁵ / ₁₆	205	90	162		11.2	7	47.3	2.0	—
Y50-N18L-A-LM	20	8 ¹ / ₂	3 ³ / ₁₆	6 ⁵ / ₁₆	205	90	162		11.2	7	47.3	2.0	—
Y50-N18L-A3	20	8 ¹ / ₂	3 ³ / ₁₆	6 ⁵ / ₁₆	205	90	162		11.2	4	47.3	2.0	—
SY50-N18L-AT {65}	20	8 ¹ / ₂	3 ³ / ₁₆	6 ⁵ / ₁₆	205	90	162		11.2	7	47.3	2.0	—
Y60-N24-A*	28	7 ¹ / ₄	4 ¹ / ₂	6 ⁵ / ₁₆	184	124	175		14.4	3	57.5	2.8	—
Y60-N24AL-B* ^{D2}	28	7 ¹ / ₄	4 ¹ / ₂	6 ⁵ / ₁₆	184	124	175		14.4	3	57.5	2.8	—
YB30L-B*	30	6 ⁵ / ₁₆	5 ³ / ₁₆	6 ⁵ / ₁₆	168	132	176		14.1	4	57.5	3.0	—
YB30CL-B*	30	6 ⁵ / ₁₆	5 ³ / ₁₆	7 ¹ / ₁₆	168	132	192.2		14.5	4	57.5	3.0	—
51814*	19 †	7 ¹ / ₁₆	3 ¹ / ₄	6 ⁵ / ₁₆	186	82	171		9.4	11	33.8	1.9	—
51913*	19 †	7 ¹ / ₁₆	3 ¹ / ₄	6 ⁵ / ₁₆	186	82	171		9.4	11	33.8	1.9	—
53030*	30 †	7 ¹ / ₁₆	5 ¹ / ₂	6 ⁵ / ₁₆	186	130	171		16.1	11	54.1	3.0	—
12N5-3B	5	4 ¹ / ₄	2 ¹ / ₂	5 ¹ / ₂	120	60	130		3.1	6	13.5	0.5	—

BATTERY SPECS.

See page 12 for footnote explanations.

BATTERY SPECIFICATION DATA

PART NO.	CAP. AH (10 HR)	DIMENSIONS (in.) (± 1/16 in.)			DIMENSIONS (mm) (± 2 mm)			ASSEMBLY FIG. (AS PER COVER POLARITY)	WEIGHT W/O ACID (lbs.)	TERM. TYPE (REFER TO PG 6)	ACID VOLUME (OUNCES)	REG. CHARGE CURRENT (AMP)	CCA @ 0°F (-18°C)
		L	W	H	L	W	H						
CONVENTIONAL DRY – 12 VOLT													
12N5-4B	5	4 $\frac{1}{4}$	2 $\frac{1}{2}$	5 $\frac{1}{2}$	120	60	130		3.1	6	13.5	0.5	—
12N5.5-3B	5.5	5 $\frac{1}{16}$	2 $\frac{1}{2}$	5 $\frac{1}{2}$	135	60	130		4.3	6	13.5	0.6	—
12N5.5-4A	5.5	5 $\frac{1}{16}$	2 $\frac{1}{2}$	5 $\frac{1}{2}$	135	60	130		4.3	2	13.5	0.6	—
12N5.5A-3B	5.5	4 $\frac{1}{16}$	3 $\frac{1}{16}$	4 $\frac{1}{2}$	103	90	114		4.3	6	16.9	0.6	—
12N7-3B	7	5 $\frac{1}{16}$	3	5 $\frac{1}{4}$	135	75	133		4.9	6	16.9	0.7	—
12N7-4A	7	5 $\frac{1}{16}$	3	5 $\frac{1}{4}$	135	75	133		4.9	6	16.9	0.7	—
12N7-4B	7	5 $\frac{1}{16}$	3	5 $\frac{1}{4}$	135	75	133		4.9	6	16.9	0.7	—
12N7D-3B	7	5 $\frac{1}{16}$	3	5 $\frac{1}{16}$	135	75	150		4.9	6	20.3	0.7	—
12N9-3A*	9	5 $\frac{1}{16}$	3	5 $\frac{1}{2}$	135	75	139		5.4	9	20.3	0.9	—
12N9-3A-1 ^{DS}	9	5 $\frac{1}{16}$	3	5 $\frac{1}{2}$	135	75	139		5.4	6	20.3	0.9	—
12N9-3B	9	5 $\frac{1}{16}$	3	5 $\frac{1}{2}$	135	75	139		5.4	6	20.3	0.9	—
12N9-4B-1	9	5 $\frac{1}{16}$	3	5 $\frac{1}{2}$	135	75	139		5.4	6	20.3	0.9	—
12N10-3A ^{DI}	10	5 $\frac{1}{16}$	3 $\frac{1}{16}$	5 $\frac{1}{4}$	135	90	145		6.4	6	27.0	1.0	—
12N10-3A-1 ^{DI}	10	5 $\frac{1}{16}$	3 $\frac{1}{16}$	5 $\frac{1}{4}$	135	90	145		6.4	6	27.0	1.0	—
12N10-3A-2 ^{DI}	10	5 $\frac{1}{16}$	3 $\frac{1}{16}$	5 $\frac{1}{4}$	135	90	145		5.8	8	27.0	1.0	—
12N11-3A-1	11	5 $\frac{1}{16}$	3 $\frac{1}{16}$	6 $\frac{1}{16}$	135	90	155		7.5	8	27.0	1.1	—
12N12A-4A-1	12	5 $\frac{1}{16}$	3 $\frac{1}{16}$	6 $\frac{1}{16}$	134	80	160		6.8	6	23.7	1.2	—
12N14-3A	14	5 $\frac{1}{16}$	3 $\frac{1}{2}$	6 $\frac{1}{16}$	134	89	166		7.5	8	27.0	1.4	—
12N24-3	24	7 $\frac{1}{4}$	4 $\frac{1}{2}$	6 $\frac{1}{2}$	184	124	175		12.1	3	40.6	2.4	—
YHD-12	28 †	8 $\frac{1}{2}$	5 $\frac{1}{4}$	6 $\frac{1}{2}$	206	133	165		13.3	9	74.4	2.8	—
CONVENTIONAL DRY – 6 VOLT													
6N2-2A	2	2 $\frac{1}{4}$	1 $\frac{1}{2}$	3 $\frac{1}{4}$	70	47	96		1.0	.4	3.4	0.2	—
6N2-2A-1	2	2 $\frac{1}{4}$	1 $\frac{1}{2}$	3 $\frac{1}{4}$	70	47	96		1.0	.4	3.4	0.2	—
6N2-2A-3	2	2 $\frac{1}{4}$	1 $\frac{1}{2}$	3 $\frac{1}{4}$	70	47	96		1.0	.4	3.4	0.2	—
6N2-2A-4	2	2 $\frac{1}{4}$	1 $\frac{1}{2}$	3 $\frac{1}{4}$	70	47	96		1.0	.4	3.4	0.2	—
6N2-2A-8	2	2 $\frac{1}{4}$	1 $\frac{1}{2}$	3 $\frac{1}{4}$	70	47	96		1.0	.4	3.4	0.2	—
6N2A-2C	2	2 $\frac{1}{4}$	1 $\frac{1}{2}$	4 $\frac{1}{16}$	70	47	106		1.0	.4	3.4	0.2	—
6N2A-2C-3	2	2 $\frac{1}{4}$	1 $\frac{1}{2}$	4 $\frac{1}{16}$	70	47	106		1.0	.4	3.4	0.2	—
6N4-2A	4	2 $\frac{1}{16}$	2 $\frac{1}{16}$	3 $\frac{1}{4}$	71	71	96		1.3	.6	6.8	0.4	—
6N4-2A-3	4	2 $\frac{1}{16}$	2 $\frac{1}{16}$	3 $\frac{1}{4}$	71	71	96		1.3	.6	6.8	0.4	—
6N4-2A-4	4	2 $\frac{1}{16}$	2 $\frac{1}{16}$	3 $\frac{1}{4}$	71	71	96		1.3	.6	6.8	0.4	—
6N4-2A-5	4	2 $\frac{1}{16}$	2 $\frac{1}{16}$	3 $\frac{1}{4}$	71	71	96		1.3	.6	6.8	0.4	—
6N4-2A-8	4	2 $\frac{1}{16}$	2 $\frac{1}{16}$	3 $\frac{1}{4}$	71	71	96		1.3	.6	6.8	0.4	—
6N4A-4D	4	2 $\frac{1}{2}$	2 $\frac{1}{4}$	5 $\frac{1}{2}$	61	57	131		1.7	.7	6.8	0.4	—
6N4B-2A	4	4	1 $\frac{1}{2}$	3 $\frac{1}{4}$	102	48	96		1.7	.7	6.8	0.4	—
6N4B-2A-3	4	4	1 $\frac{1}{2}$	3 $\frac{1}{4}$	102	48	96		1.7	.7	6.8	0.4	—
6N4B-2A-5	4	4	1 $\frac{1}{2}$	3 $\frac{1}{4}$	102	48	96		1.7	.7	6.8	0.4	—

See page 12 for footnote explanations.

BATTERY SPECS.

BATTERY SPECIFICATION DATA

BATTERY SPECS.

PART NO.	CAP. AH (10 HR)	DIMENSIONS (in.) (± 1/16 in.)			DIMENSIONS (mm) (± 2 mm)			ASSEMBLY FIG. (AS PER COVER POLARITY)	WEIGHT W/O ACID (lbs.)	TERM. TYPE (REFER TO PG 6)	ACID VOLUME (OUNCES)	REG. CHARGE CURRENT (AMP)	CCA @ 0°F (-18°C)
		L	W	H	L	W	H						
CONVENTIONAL DRY OPTION 2 – 6 VOLT (continued)													
6N4C-1B	4	2 ¹ / ₁₆	2 ¹ / ₁₆	4 ¹ / ₁₆	71	71	105		1.4	.6	6.8	0.4	—
6N5.5-1D	5.5	3 ³ / ₁₆	2 ¹ / ₁₆	3 ¹ / ₁₆	90	70	100		1.8	.8	10.1	0.6	—
6N5.5-1D-1	5.5	3 ³ / ₁₆	2 ¹ / ₁₆	3 ¹ / ₁₆	90	70	100		1.8	.8	10.1	0.6	—
6N6-1B	6	3 ³ / ₁₆	2 ¹ / ₁₆	4 ¹ / ₁₆	99	57	111		2.0	.9	10.1	0.6	—
6N6-3B	6	3 ³ / ₁₆	2 ¹ / ₁₆	4 ¹ / ₁₆	99	57	111		2.0	.9	10.1	0.6	—
6N6-3B-1	6	3 ³ / ₁₆	2 ¹ / ₁₆	4 ¹ / ₁₆	99	57	111		2.0	.9	10.1	0.6	—
6N6-1D-2	6	3 ³ / ₁₆	2 ¹ / ₁₆	4 ¹ / ₁₆	99	57	111		2.0	.9	10.1	0.6	—
B39-6*	7	4 ¹ / ₁₆	1 ¹ / ₁₆	4 ¹ / ₁₆	126	48	126		2.8	1.3	10.1	0.7	—
6N11-2D*	11	5 ¹ / ₁₆	2 ¹ / ₁₆	3 ¹ / ₁₆	150	70	100		3.5	1.6	13.5	1.1	—
6N11A-1B*	11	4 ¹ / ₁₆	2 ¹ / ₁₆	5 ¹ / ₁₆	122	62	131		3.5	1.6	13.5	1.1	—
B54-6*	12	6 ¹ / ₁₆	2 ¹ / ₁₆	4 ¹ / ₁₆	156	57	116		3.8	1.7	16.9	1.2	—
6N12A-2D*	12	6 ¹ / ₁₆	2 ¹ / ₁₆	4 ¹ / ₁₆	156	57	116		3.8	1.7	15.2	1.2	—
B38-6A*	13	4 ¹ / ₁₆	3 ¹ / ₁₆	6 ¹ / ₁₆	119	83	161		4.7	2.1	21.0	1.3	—
6YB8L-B	8	4 ¹ / ₁₆	2 ¹ / ₁₆	3 ¹ / ₁₆	120	70	95		3.0	1.4	10.5	0.8	—
6YB11-2D	11	5 ¹ / ₁₆	2 ¹ / ₁₆	3 ¹ / ₁₆	150	70	100		4.4	2.0	13.5	1.1	—

FOOTNOTES:

- {55} - Sensor NOT included with replacement battery. Disconnect sensor.
- {56} - Hold-down modifications may be necessary.
- {57} - When ordering this battery, specify sensor.
- {58} - Battery must be rotated for correct polarity. Hold-down modifications may be necessary.
- {59} - When ordering this battery, specify terminal adapter.
- {61} - Activated ready to install.
- {64} - Top and front terminal mounts only.
- {65} - Includes sensor not supplied with AGM.
- {66} - The YTX20 series batteries may be used as an optional upgrade, but some modification to the hold down may be necessary. See battery label for retrofit cautions.
- {67} - Supplied adapter may be required for proper fit.
- {71} - Height with 20mm spacer included for use in replacing YB16CL-B.
- {72} - Includes 10mm spacer for additional height required in replacing YB14A-A1 and YB14A-A2.
- {74} - Shipped with 20mm adapter.
- {75} - Shipped with 17mm adapter.
- {76} - Shipped with 10mm adapter.
- {77} - Does not meet Harley-Davidson OEM specifications.
- # - Height without adapter
- * - Dry only, not available fresh pack
- † - @ 20 hr. rate
- - Values based on DIN standard.
- ^D - Discontinued, use YB16L-B.
- ^{D1} - Discontinued when stock is depleted.
- ^{D2} - Discontinued, use 53030.
- ^{D3} - Discontinued, use YB14L-B2.
- ^{D4} - Discontinued
- ^{D5} - Discontinued, use YB9L-A2.

CC	MODEL	YEAR	PREMIUM AGM Activated/ Ready to-install	STANDARD DRY		
				STANDARD AGM	LOW MAINTENANCE-HIGH PERFORMANCE	CONVENTIONAL
AMERICAN IRONHORSE						
ALL	All Models	ALL	ETX20L	YTX20L-BS	---	---
BIG DOG						
ALL	All Models	ALL	ETX20L	YTX20L-BS	---	---
BUELL						
1200cc	Cyclone M2	2002-97	ETX20L	YTX20L-BS	---	---
	Lightning S1	1999-96	ETX14{124}	YTX14-BS{83}	---	---
	Lightning X1	2002-99	ETX20L	YTX20L-BS	---	---
	RR,RS1200	1994-89	ETX16{120}	YTX20-BS{66}	YB16-B-LM	YB16-B
	Thunderbolt S2	1996-95	ETX16{120}	YTX20-BS{66}	YB16-B-LM	YB16-B
	Thunderbolt S3	2002-97	ETX20L	YTX20L-BS	---	---
	XB12R,S	2008-04	ETX14{75}	YTX14-BS	---	---
1125cc	1125R	2008	---	YTX14L-BS	---	---
1000cc	RR1000	1988-87	ETX16{120}	YTX20-BS{66}	YB16-B-LM	YB16-B
984cc	Firebolt XB9R,Lightning XB9S	2006-02	ETX14{75}	YTX14-BS	---	---
900cc	Firebolt XB9R,Lightning XB9S	2008-07	ETX14{75}	YTX14-BS	---	---
500cc	Blast	2008-01	ETX14{75}	YTX14-BS	---	---
CAN AM						
990cc	Spyder	2008-07	ETX18L	YTX24HL-BS	---	---
CANNONDALE						
440cc	C440,E440,S440,X440,X440S	2003-02	---	YTZ7S{61}	---	---
	EX400,MX400,XC400	2001-00	---	YTZ7S	YTX5L-BS	---
EXCELSIOR-HENDERSON						
1386cc	Super X	2001-99	ETX20L	YTX20L-BS	---	---
HARLEY-DAVIDSON						
1570cc	FL/FLH Series(Touring)	2008-07	ETX30L{77}	YIX30L{61}	YB30L-B	---
	FXD Series(Dyna)	2008-07	ETX20L{77}	YTX20HL-BS	YTX20L-BS	---
	FXST, FLST Series(Softail)	2008-07	ETX20L{77}	YTX20HL-BS	YTX20L-BS	---
1450cc	FL/FLH Series(Touring)	2006-99	ETX30L{77}	YIX30L{61}	YB30L-B	---
	FLST,FXST Series(Softail)	2008-00	ETX20L{77}	YTX20HL-BS	YTX20L-BS	---
	FXD Series(Dyna)	2006-99	ETX20L{77}	YTX20HL-BS	YTX20L-BS	---
1340cc	FL/FLH Electra,Sport Glide	1984-79	---	---	---	YHD-12
	FL/FLH Electra,Sport,Tour	1996-80	ETX18L{127}	YTX24HL-BS{64}	Y50-N18L-A-LM	Y50-N18L-A
	FL/FLH Series(Touring)	1998-97	ETX30L{77}	YIX30L{61}	YB30L-B	---
	FL/FLH Series(Touring)	1997-82	ETX18L{127}	YTX24HL-BS{64}	Y50-N18L-A-LM	Y50-N18L-A
	FLST Series S,F,C(Softail)	1998-97	ETX20L{77}	YTX20HL-BS	YTX20L-BS	---
	FLST Series(Softail)	1999-97	ETX20L{77}	YTX20HL-BS	YTX20L-BS	---
	FLST Series(Softail)	1996-91	ETX16L{125}	YTX20HL-BS{66}	YTX20L-BS	YB16HL-A-LM
	FX/FXR Series	1994-79	ETX16{125}	YTX20-BS{66}	YB16-B-LM	YB16-B
	FXD Dyna	1996-91	ETX16L{125}	YTX20HL-BS{66}	YTX20L-BS	YB16HL-A-LM
	FXD Dyna	1983	ETX16L{125}	YTX20HL-BS{66}	YTX20L-BS	YB16HL-A-LM
	FXD/FXST Series(Dyna)	2006	ETX20L{77}	YTX20HL-BS	YTX20L-BS	---
	FXD/FXST Series(Dyna)	1998-97	ETX20L{77}	YTX20HL-BS	YTX20L-BS	---
	FXST Series(Softail)	1996-91	ETX16L{125}	YTX20HL-BS{66}	YTX20L-BS	YB16HL-A-LM
	FXST Softail	1998-97	ETX20L{77}	YTX20HL-BS	YTX20L-BS	---
	FXST/FLST Softail	1990-84	ETX16{125}	YTX20-BS{66}	YB16-B-LM	YB16-B
	FXSTC Series(Softail)	1996-91	ETX16L{125}	YTX20HL-BS{66}	YTX20L-BS	YB16HL-A-LM
1200cc	FL/FLH Electra,Sport Glide	1977	---	---	---	YHD-12
	FL/FLH Series(Electra Glide)	1979-65	---	---	---	YHD-12
	FX Series - Electric Start	1980-71	ETX16{125}	YTX20-BS{66}	YB16-B-LM	YB16-B
	FXE Super Glide - Kick Start	1972-71	---	---	YB7-A	12N7-4A
	XL Sportster	2008-04	---	YTX14L-BS	---	---
	XL Sportster Series	2003-97	ETX20L{77}	YTX20HL-BS	YTX20L-BS	---
	XL/XLH Sportster,Roadster	1996-88	ETX16{125}	YTX20-BS{66}	YB16-B-LM	YB16-B

{61} Activated ready to install. {64} Top and front terminal mounts only.
 {66} The YTX20 series batteries may be used as an optional upgrade. See battery label for retrofit cautions. {75} Shipped with 17mm adapter.
 {77} Does not meet Harley-Davidson OEM specifications. {83} Must use adapter kit available from Buell.
 {120} Shipped with 20mm adapter. Hold-down modifications may be necessary. {124} Shipped with 17mm adapter that may be required for proper fit.
 {125} Shipped with 20mm adapter. Hold-down modifications may be necessary. Does Not Meet Harley-Davidson OE Specs.
 {126} Shipped with 17mm adapter. Does Not meet Harley-Davidson OE Specs.
 {127} Top and front terminal mounts only. Does Not meet Harley Davidson OE Specs.

MOTORCYCLES

MOTORCYCLES

APPLICATION DATA

CC	MODEL	YEAR	PREMIUM AGM Activated/ Ready to-install	STANDARD DRY		
				STANDARD AGM	LOW MAINTENANCE- HIGH PERFORMANCE	CONVENTIONAL
HARLEY-DAVIDSON (Continued)						
1130cc	VRSC V-Rod	2008-02	ETX14{126}	YTX14-BS	---	---
1100cc	XL/XLH Sportster,Roadster	1992-86	ETX16{125}	YTX20-BS{66}	YB16-B-LM	YB16-B
1000cc	XL/XLH Sportster	1978-67	---	---	---	YHD-12
	XL/XLH Sportster,Roadster	1985-79	ETX16{125}	YTX20-BS{66}	YB16-B-LM	YB16-B
	XLCH Series	1978-70	---	---	YB7-A	12N7-4A
	XLCR Cafe Racer	1978-77	ETX16{125}	YTX20-BS{66}	YB16-B-LM	YB16-B
	XLX61,XR1000	1985-83	ETX16{125}	YTX20-BS{66}	YB16-B-LM	YB16-B
883cc	XL Sportster	2008-04	---	YTX14L-BS	---	---
	XL Sportster Series	2003-97	ETX20L{77}	YTX20HL-BS	YTX20L-BS	---
	XL/XLH Sportster,Roadster	1996-86	ETX16{125}	YTX20-BS{66}	YB16-B-LM	YB16-B
500cc	MT500 (Military)	ALL	ETX15L{77}	YTX14AHL-BS	YB14L-A2	12N14-3A
250cc	SS250,SX250	1978-75	---	---	YB7L-B	12N7-3B
175cc	SS175,SX175	1978-74	---	---	YB7L-B	12N7-3B
125cc	SS,SXT,TX 125	1978-74	---	---	YB7L-B	12N7-3B
HONDA						
1800cc	GL1800 Goldwing	2008-01	ETX20L	YTX20L-BS	---	---
	NRX1800 Valkyrie	2005-04	ETX20L	YTX20L-BS	---	---
	VTX1800	2007-02	ETX20L	YTX20L-BS	---	---
1500cc	GL1500 Goldwing	2002-88	ETX18L{64}	YTX24HL-BS{64}	Y50-N18L-A-LM	Y50-N18L-A
	GL1500 Valkyrie	2003-97	ETX14{75}	YTX14-BS	---	---
1300cc	ST1300	2006-03	---	YTZ14S{61}	---	---
	VTX1300R,S,Retro	2007-03	ETX14{75}	YTX14-BS	---	---
1200cc	GL1200 Goldwing	1987-84	ETX18L{64}	YTX24HL-BS{64}	Y50-N18L-A-LM	Y50-N18L-A
1100cc	CB1100F Supersport	1983	ETX15L	YTX14AHL-BS	YB14L-A2	12N14-3A
	CBR1100XX	2004-01	---	YTZ12S{61}	---	---
	CBR1100XX	2000-97	ETX12	YTX12-BS	---	---
	GL1100 Goldwing	1983-80	ETX18L{64}	YTX24HL-BS{64}	Y50-N18L-A-LM	Y50-N18L-A
	ST1100,ABS	2002-91	ETX14{75}	YTX14-BS	---	---
	VF1100C V65 Magna	1986-83	---	YTX20-BS{104}	YB18-A	---
	VF1100S V65 Sabre	1985-84	ETX20L{56}	YTX20L-BS{66}	YB18L-A	---
	VT1100	2007-00	ETX14{75}	YTX14-BS	---	---
	VT1100 Shadow Ace,Spirit,Aero	2000-85	---	---	HYB16A-AB	---
1050cc	CBX	1982-79	ETX20L{56}	YTX20L-BS{66}	YB18L-A	---
1000cc	CB1000	1995-94	ETX12	YTX12-BS	---	---
	CB1000C Custom	1983	ETX15L	YTX14AHL-BS	YB14L-B2	---
	CBR1000F Hurricane	1996-87	ETX15L	YTX14AHL-BS	YB14L-B2	---
	CBR1000RR	2007-04	---	YTZ10S{61}	---	---
	GL1000 Goldwing	1979-75	ETX18L{64}	YTX24HL-BS{64}	Y50-N18L-A-LM	Y50-N18L-A
	RVT1000R	2006-00	---	YTZ12S{61}	---	---
	VF1000R Interceptor	1986-84	ETX14{119}	---	YB16B-A	---
	VTR1000F Super Hawk	2000-97	ETX12	YTX12-BS	---	---
	VTR1000F SuperHawk	2005-01	---	YTZ12S{61}	---	---
954cc	CBR954RR	2003-02	---	YTZ10S{61}	---	---
929cc	CBR929RR	2001-00	---	YTZ10S{61}	---	---
919cc	CB900F(919)	2006-02	---	YTZ10S{61}	---	---
900cc	CB900C,F	1982-80	ETX15L	YTX14AHL-BS	YB14L-A2	12N14-3A
	CBR900RR	1999-93	ETX9	YTX9-BS	---	---
800cc	PC800 Pacific Coast	1998-89	ETX12	YTX12-BS	---	---
	VFR800 Interceptor	2007-02	---	YTZ12S{61}	---	---
	VFR800F1 Interceptor	2001-98	ETX12	YTX12-BS	---	---
	VT800C Shadow	1988	ETX15{76}	YTX14AH-BS	YB14-B2	---
750cc	CB750 Nighthawk	2003-91	ETX15{76}	YTX14AH-BS	YB14-A2	---
	CB750A Hondamatic	1978-76	ETX18L{64}	YTX24HL-BS{64}	Y50-N18L-A-LM	Y50-N18L-A

{55} Sensor NOT included with replacement battery. Disconnect sensor. {56} Hold-down modifications may be necessary.

{61} Activated ready to install. {64} Top and front terminal mounts only. {65} Includes sensor not supplied with AGM.

{66} The YTX20 series batteries may be used as an optional upgrade. See battery label for retrofit cautions.

{75} Shipped with 17mm adapter. {76} Shipped with 10mm adapter. {77} Does not meet Harley-Davidson OEM specifications.

{104} Hold-down modifications may be necessary. Requires activation.

{119} Shipped with 17mm adapter. Top and front terminal mounts only. Hold-down modifications may be necessary.

{125} Shipped with 20mm adapter. Hold-down modifications may be necessary. Does Not Meet Harley-Davidson OE Specs.

{126} Shipped with 17mm adapter. Does Not meet Harley-Davidson OE Specs.

APPLICATION DATA

MOTORCYCLES

CC	MODEL	YEAR	PREMIUM AGM Activated/ Ready to-install	STANDARD DRY		
				STANDARD AGM	LOW MAINTENANCE-HIGH PERFORMANCE	CONVENTIONAL
HONDA (Continued)						
750cc	CB750C Custom	1982-80	ETX15L	YTX14AHL-BS	YB14L-A2	12N14-3A
	CB750F Supersport	1982-75	ETX15L	YTX14AHL-BS	YB14L-A2	12N14-3A
	CB750K, Limited	2001-99	ETX15L	YTX14AHL-BS	YB14L-A2	12N14-3A
	CB750K, Limited	1994	ETX15L	YTX14AHL-BS	YB14L-A2	12N14-3A
	CB750K, Limited	1982-69	ETX15L	YTX14AHL-BS	YB14L-A2	12N14-3A
	CB750SC Nighthawk	1983-82	ETX15L	YTX14AHL-BS	YB14L-A2	12N14-3A
	RVF750R	1994	ETX9	YTX9-BS	—	—
	VF750C Magna	1988	—	—	YB12A-A	12N12A-4A-1
	VF750C V45 Magna	1983-82	ETX15{76}	YTX14AH-BS	YB14-A2	—
	VF750C,D Magna	2003-95	ETX12	YTX12-BS	—	—
	VF750F V45 Interceptor	1984-83	ETX15{76}	YTX14AH-BS	YB14-A2	—
	VF750S V45 Sabre	1983-82	ETX15L{55}	—	SYB14L-A2{65}	—
	VFR750F	1997-90	ETX12	YTX12-BS	—	—
	VFR750F Interceptor	1986	—	—	YB12A-B	—
	VFR750R	1990	ETX9	YTX9-BS	—	—
	VT750C Shadow	1983	—	—	HYB16A-AB	—
	VT750C,CA	2008-04	—	YTZ12S{61}	—	—
	VT750C,D Shadow, Ace Deluxe	2003-98	ETX14{75}	YTX14-BS	—	—
	VT750DC	2007-01	—	YTZ14S{61}	—	—
700cc	CB700SC Nighthawk	1986-84	ETX15L{64}	—	YB14L-A1	—
	VF700C Magna	1987	—	—	YB12A-A	12N12A-4A-1
	VF700C Magna	1986-84	ETX15{76}	YTX14AH-BS	YB14-A2	—
	VF700F Interceptor	1985-84	ETX15{76}	YTX14AH-BS	YB14-A2	—
	VF700S Sabre	1985-84	ETX15L	YTX14AHL-BS	YB14L-A2	12N14-3A
	VFR700F Interceptor	1987-86	—	—	YB12A-B	—
	VT700C Shadow	1987-86	ETX15{76}	YTX14AH-BS	YB14-B2	—
	VT700C Shadow	1985-84	—	—	HYB16A-AB	—
650cc	CB650, Custom	1982-79	—	—	YB12A-A	12N12A-4A-1
	CB650SC Nighthawk	1985-83	—	—	YB12AL-A	—
	CX650C Custom	1983	ETX15{76}	YTX14AH-BS	YB14-A2	—
	CX650T Turbo	1983	ETX15L	YTX14AHL-BS	YB14L-A2	12N14-3A
	GL650I Silverwing Interstate	1983	ETX15L	YTX14AHL-BS	YB14L-A2	12N14-3A
	NT650 Hawk GT	1991-88	ETX9	YTX9-BS	—	—
	NX650	1989-88	ETX9	YTX9-BS	—	—
	XR650L	2007-93	ETX9	YTX9-BS	—	—
600cc	CB600F	2006-04	—	YTX7L-BS	—	—
	CBR600	2000-87	ETX9	YTX9-BS	—	—
	CBR600F4i,CBR600RR	2006-01	—	YTZ10S{61}	—	—
	VT600C,CD,Shadow Deluxe,VLX	2003-88	ETX9	YTX9-BS	—	—
	VT600CD Shadow Deluxe	2007-04	—	YTZ10S{61}	—	—
	XL600 TransAlp	1990-89	—	—	YB12A-B	—
	XL600R	1987-83	—	—	YB3L-A	—
550cc	CB550 Four,K,SS	1978-74	—	—	YB12A-A	12N12A-4A-1
	CB550SC Nighthawk	1983	—	—	YB12AL-A	—
500cc	CB500,Four, Twin	1976-71	—	—	YB12A-A	12N12A-4A-1
	CX500,C,D,T	1982-78	ETX15L	YTX14AHL-BS	YB14L-A2	12N14-3A
	FT500 Ascot	1983-82	ETX15L	YTX14AHL-BS	YB14L-A2	12N14-3A
	GB500	1990-89	—	—	YB12A-B	—
	GL500 Interstate,Silver Wing	1982-81	ETX15L	YTX14AHL-BS	YB14L-A2	12N14-3A
	VF500C V30 Magna	1985-84	—	—	YB12A-A	12N12A-4A-1
	VF500F Interceptor	1986-84	—	—	YB12A-A	12N12A-4A-1
	VT500C Shadow	1986-83	—	—	YB12A-A	12N12A-4A-1
	VT500FT Ascot	1984-83	—	—	YB12A-A	12N12A-4A-1
	XL500R	1982	—	—	YB3L-A	—
	XL500S	1981-79	—	—	—	6N4-2A-4
450cc	CB450,SS	1974-65	—	—	YB12A-A	12N12A-4A-1
	CB450SC Nighthawk,T	1986-82	—	—	YB12A-A	12N12A-4A-1
	CL450,Scrambler	1974-68	—	—	YB12A-A	12N12A-4A-1
	CM450A Hondamatic,E	1983-82	—	—	YB12A-A	12N12A-4A-1

MOTORCYCLES

MOTORCYCLES

APPLICATION DATA

CC	MODEL	YEAR	PREMIUM AGM Activated/ Ready to-install	STANDARD DRY		
				STANDARD AGM	LOW MAINTENANCE- HIGH PERFORMANCE	CONVENTIONAL
HONDA (Continued)						
450cc	CMX450C Rebel	1987-86	---	---	YB12A-A	12N12A-4A-1
	CRF450X	2007-05	---	YTZ7S{61}	---	---
400cc	CB400A	1978	---	---	YB12A-A	12N12A-4A-1
	CB400F	1990-89	ETX9	YTX9-BS	---	---
	CB400F,T,Hawk, Supersport	1981-80	---	---	YB12A-A	12N12A-4A-1
	CB400F,T,Hawk, Supersport	1977-75	---	---	YB12A-A	12N12A-4A-1
	CB400T1,II Hawk	1979-78	---	---	YB9-B	12N9-4B-1
	CM400 (All)	1981-79	---	---	YB12A-A	12N12A-4A-1
360cc	CB360G,T	1977-74	---	---	YB12A-A	12N12A-4A-1
	CJ360T	1977-76	---	---	YB9-B	12N9-4B-1
	CL360	1975-74	---	---	YB12A-A	12N12A-4A-1
350cc	CB,CL 350	1974-68	---	---	YB12A-A	12N12A-4A-1
	SL350	1974-71	---	---	---	12N5-4B
	SL350	1970-69	---	---	YB12A-A	12N12A-4A-1
	XL350	1978-74	---	---	---	6N6-3B
	XL350R	1985-84	---	---	YB3L-A	---
305cc	CA77DT,CB77Super Hawk	1969-60	---	---	---	12N9-3A
	CL77 Scrambler	1968-65	---	---	---	12N5-4B
250cc	CA72 Dream,CB72 Hawk	1967-60	---	---	---	12N9-3A
	CB250 Nighthawk	2007-91	---	YTX7L-BS	---	---
	CL72	1965-62	---	---	---	12N5-4B
	CM250C Custom	1983-82	---	---	YB9-B	12N9-4B-1
	CMX250C Rebel	2007-96	---	YTX7L-BS	---	---
	CMX250C Rebel	1987-85	---	---	YB9L-B	12N9-3B
	CRF250X	2007-04	---	YTX5L-BS	---	---
	MT250	1976-74	---	---	---	6N6-3B
	NX250	1990-88	---	YTX7L-BS	---	---
	VTR250 Interceptor	1990-88	---	---	YB9-B	12N9-4B-1
	XL250	1976-72	---	---	---	6N6-3B
	XL250R	1987-82	---	---	YB3L-A	---
	XL250S	1981-78	---	---	---	6N4-2A-4
	XR250L	1996-91	---	YTX4L-BS	---	---
230cc	CRF230F	2007-03	---	YTX5L-BS	---	---
200cc	CB200T	1976-74	---	---	YB9-B	12N9-4B-1
	CL200	1974	---	---	YB9-B	12N9-4B-1
	CM200T Twinstar	1982-81	---	---	YB9-B	12N9-4B-1
	CM200T Twinstar	1980	---	---	---	6N12A-2D
	TLR200 Reflex	1987-86	---	YTX4L-BS	---	---
	TR200 Fat Cat	1987-86	ETX9	YTX9-BS	---	---
	XL200R	1984-83	---	---	YB3L-A	---
185cc	CM185T Twinstar	1979-78	---	---	---	6N12A-2D
	XL185S	1983-79	---	---	---	6N4-2A-4
175cc	CA175	1970	---	---	---	6N12A-2D
	CA175	1969-68	---	---	---	B54-6
	CB175K	1974-69	---	---	YB9-B	12N9-4B-1
	CL175 Series	1974-68	---	---	YB9-B	12N9-4B-1
	SL175	1973-70	---	---	---	12N5-4B
	XL175	1978-73	---	---	---	6N6-3B
160cc	CA,CB,CL 160	1969-65	---	---	YB9-B	12N9-4B-1
150cc	CA95	1966-59	NA	---	---	---
	CRF150	2007-06	---	YTX5L-BS	---	---
125cc	CB125S	1983-81	---	---	---	6N6-3B-1
	CB125S	1980-73	---	---	---	6N6-3B
	CB92	1963-59	NA	---	---	---
	CL125A Scrambler(Twin)	1969-67	---	---	---	B54-6
	CL125S	1975-73	---	---	---	6N4C-1B
	CT125 Trail	1977	---	---	---	6N4C-1B

{61} Activated ready to install. {64} Top and front terminal mounts only.
 {124} Shipped with 17mm adapter that may be required for proper fit.

APPLICATION DATA

MOTORCYCLES

CC	MODEL	YEAR	PREMIUM AGM Activated/ Ready to-install	STANDARD DRY		
				STANDARD AGM	LOW MAINTENANCE- HIGH PERFORMANCE	CONVENTIONAL
HONDA (Continued)						
125cc	MT125	1976-74	---	---	---	6N6-3B
	NX125	1990-88	---	YTX7L-BS	---	---
	SL125	1974-71	---	---	---	6N6-3B
	SS125	1969-67	---	---	---	B54-6
	XL125	1978-74	---	---	---	6N4C-1B
	XL125S	1985	---	---	YB2.5L-C	---
	XL125S	1984-79	---	---	---	6N4-2A-4
110cc	CT110	1986	---	---	---	6N4-2A-4
	CT110	1984-80	---	---	---	6N4-2A-8
100cc	CB100	1974-70	---	---	---	6N6-3B
	CL100,S	1974-70	---	---	---	6N6-3B
	SL100	1974-70	---	---	---	6N6-3B
	XL100	1978-77	---	---	---	6N4C-1B
	XL100	1976-74	---	---	---	6N6-3B
	XL100S	1985-83	---	---	---	6N4-2A-4
	XL100S	1982-81	---	---	---	6N4C-1B
	XL100S	1980-79	---	---	---	6N4-2A-4
90cc	CA200 Honda 90	1966-63	---	---	---	6N6-1D
	CL90	1970-67	---	---	---	6N5.5-1D
	CM90,CM91	1969-66	---	---	---	6N6-1B
	CT90 Trail	1979-64	---	---	---	6N5.5-1D
	EZ90 Cub	1996-91	---	YTX5L-BS	---	---
	S90 Super	1969-64	---	---	---	6N6-1B
	SL90	1969	---	---	---	6N5.5-1D
	ST90	1975-73	---	---	---	6N5.5-1D
80cc	XL80S	1985-83	---	---	---	6N4-2A-8
	XL80S	1982-80	---	---	---	6N4C-1B
75cc	XL75	1979-77	---	---	---	6N4C-1B
70cc	C70 Passport	1983-82	---	---	YB5L-B	12N5-3B
	C70 Passport	1981-79	---	---	6YB11-2D	6N11-2D
	C70K1,M	1974-70	---	---	6YB11-2D	6N11-2D
	C70M	1974-73	---	---	6YB11-2D	6N11-2D
	C70M	1971	---	---	6YB11-2D	6N11-2D
	CL70	1974-69	---	---	---	6N5.5-1D-1
	CT70	1997	---	YTX4L-BS	---	---
	CT70	1994-91	---	YTX4L-BS	---	---
	CT70	1977-76	---	---	---	6N4C-1B
	CT70	1971-69	---	---	---	6N2A-2C
	CT70H	1974-70	---	---	---	6N2A-2C-3
	SL70	1973-71	---	---	---	6N2A-2C
	XL70	1976-74	---	---	---	6N4C-1B
65cc	S65	1969-65	---	---	---	6N2-2A
55cc	CA105T	1965-62	---	---	---	6N2-2A
50cc	C,100,CA100,T,110	1970-59	---	---	---	6N2-2A
	CHF50 Metro,II	2003-02	---	YTZ7S{61}	---	---
	MB5	1982	---	---	YB2.5L-C	---
	NS50	1990	---	---	YB3L-A	---
	NZ50	1987-86	---	---	YB4L-B	---
	P50	1968-67	---	---	---	6N4-2A-4
	Z50A(K1)	1970-68	---	---	---	6N2A-2C-1
	ZB50	1988	---	YTX4L-BS	---	---
KAWASAKI						
2000cc	VN2000-A Vulcan	2008-04	ETX14{124}	YTX20CH-BS	YTX16-BS	---
1600cc	VN1600-A Vulcan,Nomad	2008-03	ETX14{124}	YTX20CH-BS	YTX16-BS	---
1500cc	VN1500 Vulcan 88	1997-87	ETX18L{64}	YTX24HL-BS{64}	Y50-N18L-A-LM	Y50-N18L-A
	VN1500 Vulcan Classic	2008-98	ETX14{124}	YTX20CH-BS	YTX16-BS	---
	VN1500G,J,L,R Nomad,Drifter	2006-99	ETX14{124}	YTX20CH-BS	YTX16-BS	---
1400cc	ZX14 Ninja	2008-06	ETX14{124}	YTX14H-BS	YTX14-BS	---
1300cc	KZ1300 Voyager	1982-79	ETX18L{64}	YTX24HL-BS{64}	Y50-N18L-A-LM	Y50-N18L-A

MOTORCYCLES

MOTORCYCLES

APPLICATION DATA

CC	MODEL	YEAR	PREMIUM AGM Activated/ Ready to-install	STANDARD DRY		
				STANDARD AGM	LOW MAINTENANCE- HIGH PERFORMANCE	CONVENTIONAL
KAWASAKI (Continued)						
1300cc	ZN1300 Voyager	1988-83	ETX16L{118}	---	---	12N24-3
1200cc	ZG1200 Voyager XII	2003-86	ETX18L{115}	YTX24HL-BS{115}	SY50-N18L-AT{65}	---
	ZRX1200R	2005-01	ETX14{124}	YTX14H-BS	YTX14-BS	---
	ZX-12R	2005-00	ETX14{124}	YTX14H-BS	YTX14-BS	---
	ZX1200	2002-00	ETX14{124}	YTX14H-BS	YTX14-BS	---
	ZZR1200	2005-02	ETX14{124}	YTX14H-BS	YTX14-BS	---
1100cc	KZ1100	1981	ETX20L{56}	YTX20L-BS{66}	YB18L-A	---
	KZ1100 GPZ	1982	ETX16L{116}	---	YB16L-B{112}	---
	KZ1100 LTD	1983-81	ETX20L{56}	YTX20L-BS{66}	YB18L-A	---
	ZN1100 LTD	1985-84	ETX15L	YTX14AHL-BS	YB14L-A2	12N14-3A
	ZR1100	1993	ETX14{124}	YTX20CH-BS	YTX16-BS	---
	ZRX1100	2000-99	ETX14{75}	YTX14-BS	---	---
	ZX1100 GPZ	1984-83	ETX16L{116}	---	YB16L-B{112}	---
	ZX1100 GPZ,ABS	1997-95	ETX14{75}	YTX14-BS	---	---
	ZX1100 Ninja ZX-11	1993-91	ETX15L	YTX14AHL-BS	YB14L-A2	12N14-3A
	ZX1100D Ninja ZX-11	2001-94	ETX14{75}	YTX14-BS	---	---
1000cc	KZ1000	1982-80	ETX20L{56}	YTX20L-BS{66}	YB18L-A	---
	KZ1000	1977	ETX15L	YTX14AHL-BS	YB14L-A2	12N14-3A
	KZ1000 CSR,LTD	1983-81	ETX20L{56}	YTX20L-BS{66}	YB18L-A	---
	KZ1000 Replica	1983-82	ETX20L{56}	YTX20L-BS{66}	YB18L-A	---
	KZ1000, LTD	1980-77	ETX15L	YTX14AHL-BS	YB14L-A2	12N14-3A
	KZ1000C,Police	1981-80	ETX16L{120}	YTX20L-BS	YB16L-B	12N16-3B
	KZ1000E,Shaft	1980-79	ETX16L{120}	YTX20L-BS	YB16L-B	12N16-3B
	KZ1000G	1980	ETX15L	YTX14AHL-BS	YB14L-A2	12N14-3A
	KZ1000P,Police	2005-02	ETX20L	YTX20L-BS	---	---
	KZ1000P,Police	2001-81	ETX20L{56}	YTX20L-BS{66}	YB18L-A	---
	Z1000	2008-03	ETX9	YTX9-BS	---	---
	ZG1000 Concours	2006-86	ETX20L{56}	YTX20L-BS{66}	YB18L-A	---
	ZL1000 Eliminator	1987	ETX15L	YTX14AHL-BS	YB14L-A2	12N14-3A
	ZX1000 Ninja	1990-86	ETX15L	YTX14AHL-BS	YB14L-A2	12N14-3A
	ZX1000C Ninja ZX-10R	2008-04	---	YT12B-BS{56}	---	---
900cc	900Z	1975-73	ETX15L	YTX14AHL-BS	YB14L-A2	12N14-3A
	KZ900	1977-76	---	---	YB10L-A2	---
	Vulcan 900 Classic	2008-06	ETX12	YTX12-BS	---	---
	ZL900 Eliminator	1986-85	ETX15L	YTX14AHL-BS	YB14L-A2	12N14-3A
	ZX900 Ninja	1986-84	ETX15L	YTX14AHL-BS	YB14L-A2	12N14-3A
	ZX900 Ninja ZX-9R	2003-98	ETX9	YTX9-BS	---	---
	ZX900 Ninja ZX-9R	1997-94	ETX12	YTX12-BS	---	---
800cc	VN800 Vulcan Classic,Drifter	2006-04	ETX12	YTX12-BS	---	---
	VN800 Vulcan,Classic	2003-95	ETX14{75}	YTX14-BS	---	---
750cc	H2	1975-72	---	---	---	12N5.5-4A
	KZ750	1983-82	---	---	YB12A-A	12N12A-4A-1
	KZ750	1979-76	ETX15L{55}	---	SYB14L-A2{65}	---
	KZ750 Spectre	1983-82	ETX15L	YTX14AHL-BS	YB14L-A2	12N14-3A
	KZ750, LTD	1983-81	---	---	YB12A-A	12N12A-4A-1
	KZ750, LTD	1980	---	---	YB12A-A	12N12A-4A-1
	KZ750, LTD	1980	ETX15L	YTX14AHL-BS	YB14L-A2	12N14-3A
	KZ750R1 GPZ	1982	---	---	YB12A-A{57}	---
	VN750A Vulcan	2006-86	ETX15L	YTX14AHL-BS	YB14L-A2	12N14-3A
	ZR-7,S	2003-00	ETX12	YTX12-BS	---	---
	ZR750, S	2006-05	ETX9	YTX9-BS	---	---
	ZR750C,Zephyr	1992-91	ETX12	YTX12-BS	---	---
	ZX750 GPZ	1985-83	ETX15L{55}	---	SYB14L-A2{65}	---
	ZX750 Ninja R	1990-87	ETX15L	YTX14AHL-BS	YB14L-A2	12N14-3A

{55} Sensor NOT included with replacement battery. Disconnect sensor. {56} Hold-down modifications may be necessary.

{57} When ordering battery, specify sensor. {59} When ordering battery, specify terminal adapter. {65} Includes sensor not supplied with AGM.

{66} The YTX20 series batteries may be used as an optional upgrade, See battery label for retrofit cautions. {75} Shipped with 17mm adapter.

{112} Sensor NOT included with replacement battery. Disconnect sensor.Requires activation.

{115} Sensor NOT included with replacement battery. Disconnect sensor.Top and front terminal mounts only.

{116} Shipped with 20mm adapter. Sensor NOT included. Disconnect sensor. {118} Shipped with 20mm adapter.Top and front terminal mounts only.

{120} Shipped with 20mm adapter. Hold-down modifications may be necessary. {124} Shipped with 17mm adapter that may be required for proper fit.

APPLICATION DATA

MOTORCYCLES

CC	MODEL	YEAR	PREMIUM AGM Activated/ Ready to-install	STANDARD DRY		
				STANDARD AGM	LOW MAINTENANCE- HIGH PERFORMANCE	CONVENTIONAL
KAWASAKI (Continued)						
750cc	ZX750 Ninja ZX-7	1995-91	ETX12	YTX12-BS	—	—
	ZX750 Ninja ZX-7	1990	—	—	YB12AL-A{59}	—
	ZX750 Ninja ZX-7	1989	ETX15L	YTX14AHL-BS	YB14L-A2	12N14-3A
	ZX750 Ninja ZX-7RR	1997-91	ETX9	YTX9-BS	—	—
	ZX750P, Ninja ZX-7R	2003-91	ETX12	YTX12-BS	—	—
700cc	KZ700 Sports	1984	—	—	YB12A-A	12N12A-4A-1
	VN700 Vulcan	1985	ETX15L	YTX14AHL-BS	YB14L-A2	12N14-3A
	ZN700 LTD	1985-84	ETX15L	YTX14AHL-BS	YB14L-A2	12N14-3A
650cc	KL650A,KLR	2008-87	ETX15L	YTX14AHL-BS	YB14L-A2	12N14-3A
	KLX650	1996-93	ETX9	YTX9-BS	—	—
	KZ650 CSR	1983-81	—	—	YB12A-A	12N12A-4A-1
	KZ650 Series	1980-77	—	—	YB10L-A2	—
	Ninja 650R	2008-06	ETX12	YTX12-BS	—	—
	W Series	1969-66	—	—	YB7L-B	12N7-3B
	W650	2002-00	ETX14{75}	YTX14-BS	—	—
600cc	KL600A	1984	—	—	YB4L-A	—
	KL600B	1986-85	ETX15L	YTX14AHL-BS	YB14L-A2	12N14-3A
	ZL600 Eliminator	1997-96	—	—	YB12A-A	12N12A-4A-1
	ZL600 Eliminator	1987-86	—	—	YB12A-A	12N12A-4A-1
	ZX600 Ninja R	1997-85	—	—	YB12A-A	12N12A-4A-1
	ZX600 Ninja ZX-6	1998-90	—	—	YB12A-A	12N12A-4A-1
	ZX600 Ninja ZX-6R	2002-95	ETX12	YTX12-BS	—	—
	ZX600E	2002-99	ETX12	YTX12-BS	—	—
	ZX600G,J	2002-99	ETX9	YTX9-BS	—	—
550cc	KZ550	1983-82	—	—	YB12A-A{57}	—
	KZ550	1981-80	—	—	YB12A-A	12N12A-4A-1
	KZ550 GPZ,LTD	1984	—	—	YB12A-A{59}	—
	KZ550 GPZ,LTD	1983-81	—	—	YB12A-A	12N12A-4A-1
	KZ550 Spectre	1983	—	—	YB12A-A{59}	—
	ZR550 Zephyr	1991-90	—	—	YB12A-A	12N12A-4A-1
	ZX550 GPZ	1985-84	—	—	YB12A-A	12N12A-4A-1
500cc	EN500A Vulcan	1996-90	—	—	YB12A-A	12N12A-4A-1
	EN500C Vulcan LTD	2008-96	—	—	YB12AL-A2	—
	EX500A,D Ninja, R	2008-87	ETX15L	YTX14AHL-BS	YB14L-A2	12N14-3A
	H1 Series	1975-73	—	—	YB9L-B	12N9-3B
	H1 Series	1972-69	—	—	YB9-B	12N9-4B-1
	KH500	1976	—	—	YB9L-B	12N9-3B
450cc	EN450A LTD	1990-85	—	—	YB12A-A	12N12A-4A-1
440cc	KZ440 (All)	1983-80	—	—	YB12A-A	12N12A-4A-1
400cc	KH400	1977-76	—	—	—	12N5.5-4A
	KZ400	1979-74	—	—	YB12A-A	12N12A-4A-1
	S3	1975-74	—	—	—	12N5.5-4A
350cc	A7 Series	1971-67	—	—	YB9-B	12N9-4B-1
	F5	1971-70	—	—	—	6N2-2A-3
	F9	1975-73	—	—	—	6N4B-2A-3
	F9	1972	—	—	—	6N2-2A-3
	S2	1973-72	—	—	—	12N5.5-4A
305cc	EX305B GPZ	1983	—	—	YB9L-A2	—
	KZ305 CSR,LTD	1988-87	—	—	YB10L-A2	—
	KZ305 CSR,LTD	1983-81	—	—	YB10L-A2	—
250cc	A1 Series	1971-67	—	—	YB9-B	12N9-4B-1
	EL250, Eliminator	1991	—	—	YB9L-A2	—
	EL250, Eliminator	1989-88	—	—	YB9L-A2	—
	EX250Ninja	2007-95	—	YTX7L-BS	—	—
	EX250Ninja	1994-86	—	—	YB9L-A2	—
	F11	1975-73	—	—	—	6N4B-2A-3
	F4	1970-69	—	—	—	12N5.5-4A
	F8	1972-71	—	—	—	6N2-2A-3
	KE250	1982	—	—	—	6N6-1D-2

MOTORCYCLES

MOTORCYCLES

APPLICATION DATA

CC	MODEL	YEAR	PREMIUM AGM Activated/ Ready to-install	STANDARD DRY		
				STANDARD AGM	LOW MAINTENANCE- HIGH PERFORMANCE	CONVENTIONAL
KAWASAKI (Continued)						
250cc	KE250	1979-77	---	---	---	6N6-1D-2
	KH250	1976	---	---	---	12N5.5-4A
	KL250 Super Sherpa	2004-00	---	YTX7L-BS	---	---
	KL250A	1983-78	---	---	---	6N6-1D-2
	KL250D,KLR	2005-85	---	---	YB4L-A	---
	KLX250S	2007-06	---	YTX7L-BS	---	---
	KZ250 CSR,LTD	1983-80	---	---	YB10L-A2	---
	S Series	1975-72	---	---	---	12N5.5-4A
200cc	KZ200	1979-78	---	---	YB10L-B	12N10-3B
175cc	F7	1975-71	---	---	---	6N4-2A-5
	KE175	1978-76	---	---	---	6N6-1D-2
150cc	B Series	1966-65	---	---	YB9-B	12N9-4B-1
125cc	B Series	2007-01	---	---	YB9-B	12N9-4B-1
	B Series	1966-65	---	---	YB9-B	12N9-4B-1
	C2 Series	1969-67	---	---	---	6N4-2A-3{60}
	F6	1973-71	---	---	---	6N4-2A-5
	KE125	1982-76	---	---	---	6N6-1D-2
	KS125	1975-74	---	---	---	6N6-1D-2
100cc	G3TR - G3SS & G3TR models having engine production #23561	1971	---	---	---	6N4-2A-3{60}
	G4TR	1975-74	---	---	---	6N4-2A-5
	G4TR	1973-70	---	---	---	6N4-2A-3{60}
	G5	1975-72	---	---	---	6N4-2A-3{60}
	KE100	1978-76	---	---	---	6N4-2A-5
	KE100 Series	2001-79	---	---	---	6N6-1D-2
	KH100	1976	---	---	---	6N4-2A-5
	KM100	1981-79	---	---	---	6N6-1D-2
	KM100	1978-76	---	---	---	6N4-2A-5
	KV100	1976	---	---	---	6N6-1D-2
90cc	G3SS - G3SS & G3TR models having engine production #23561	1975-69	---	---	---	6N4-2A-3{60}
	G3TR	1969	---	---	---	6N4-2A-3{60}
	G3TR - G3SS & G3TR models having engine production #23561	1971-69	---	---	---	6N4-2A-3{60}
	MC1 Series	1975-73	---	---	---	6N4-2A-5
80cc	A1 Series	1982	---	---	YB9-B	12N9-4B-1
50cc	A1 Series	1982	---	---	YB9-B	12N9-4B-1
POLARIS (VICTORY)						
1500cc	V92C,DC	2003-98	ETX20L	YTX20L-BS	---	---
	V92SC	2001-00	ETX20L	YTX20L-BS	---	---
	V92TC	2006-02	ETX20L	YTX20L-BS	---	---
	V92V	2007-03	ETX20L	YTX20L-BS	---	---
SUZUKI						
1800cc	VZR1800(M109R)	2008-06	---	YTX20CH-BS	---	---
1600cc	M95	2005	ETX14{124}	YTX20CH-BS	YTX16-BS	---
	Marauder	2005-04	ETX14{124}	YTX20CH-BS	YTX16-BS	---
1500cc	C90(Intruder)	2006-05	ETX14{119}	YTX16-BS-1	---	---
	VL1500 Intruder	2007-98	ETX14{119}	YTX16-BS-1	---	---
1400cc	GV1400G,C,D Cavalcade	1989-86	ETX18L{115}	YTX24HL-BS{115}	SY50-N18L-AT{65}	---
	VS1400GLP Intruder	2007-87	ETX14{119}	YTX16-BS-1	---	---
1300cc	GSX1300BK	2008	---	YT12A-BS	---	---
	GSX1300R	2008-99	---	YT12A-BS	---	---
1200cc	GSF1200,S Bandit	2005-97	ETX12	YTX12-BS	---	---
	GV1200GL Madura	1986-85	ETX15L	YTX14AHL-BS	YB14L-A2	12N14-3A
1150cc	GS1150E,S	1986-83	ETX15L{55}	---	SYB14L-B2{65}	---

{55} Sensor NOT included with replacement battery. Disconnect sensor.

{65} Includes sensor not supplied with AGM. {75} Shipped with 17mm adapter.

{115} Sensor NOT included with replacement battery. Disconnect sensor. Top and front terminal mounts only.

{119} Shipped with 17mm adapter. Top and front terminal mounts only. Hold-down modifications may be necessary.

{121} Shipped with 17mm adapter. Hold-down modifications may be necessary. {124} Shipped with 17mm adapter that may be required for proper fit.

APPLICATION DATA

MOTORCYCLES

CC	MODEL	YEAR	PREMIUM AGM Activated/ Ready to-install	STANDARD DRY			
				STANDARD AGM	LOW MAINTENANCE- HIGH PERFORMANCE	CONVENTIONAL	
SUZUKI (Continued)							
1100cc	GS1100E,S	1983-80	ETX15L{55}	—	SYB14L-B2{65}	—	
	GS1100G,K,L	1984-80	ETX15L	YTX14AHL-BS	YB14L-A2	12N14-3A	
	GSX1100F Katana	1993-88	ETX15L	YTX14AHL-BS	YB14L-A2	12N14-3A	
	GSX1100G	1993-91	ETX14{75}	YTX14-BS	—	—	
	GSXR1100	1992-86	ETX15L	YTX14AHL-BS	YB14L-A2	12N14-3A	
	GSXR1100W	1998-93	ETX12	YTX12-BS	—	—	
1000cc	DL1000	2008-02	ETX14{75}	YTX14-BS	—	—	
	GS1000	1982-78	ETX15L	YTX14AHL-BS	YB14L-A2	12N14-3A	
	GSXR1000	2008-05	—	YT12A-BS	—	—	
	GSXR1000	2004-01	ETX12	YTX12-BS	—	—	
	SV1000	2007-03	ETX14{75}	YTX14-BS	—	—	
	TL1000R	2003-98	—	YT12A-BS	—	—	
	TL1000S	2002-97	ETX12	YTX12-BS	—	—	
900cc	RF900R	1997-94	ETX9	YTX9-BS	—	—	
850cc	GS850G,GL	1986	ETX15L	YTX14AHL-BS	YB14L-A2	12N14-3A	
	GS850G,GL	1983-79	ETX15L	YTX14AHL-BS	YB14L-A2	12N14-3A	
800cc	C50 Boulevard(Volusia)	2006-05	ETX12	YTX12-BS	—	—	
	M50(Marauder)	2006-05	ETX12	YTX12-BS	—	—	
	S50 Boulevard(Intruder)	2006-05	ETX14{121}	—	YB16B-A1	—	
	VL800	2008-01	ETX12	YTX12-BS	—	—	
	VS800GL, Intruder	2008-92	ETX14{121}	—	YB16B-A1	—	
	VX800	1993-90	ETX14{119}	—	YB16B-A	—	
	VZ800 Marauder	2008-97	ETX12	YTX12-BS	—	—	
750cc	GS750, Katana	1983-77	ETX15L	YTX14AHL-BS	YB14L-A2	12N14-3A	
	GSX750F Katana	2006-98	ETX9	YTX9-BS	—	—	
	GSX750F Katana	1997-89	ETX15L	YTX14AHL-BS	YB14L-A2	12N14-3A	
	GSXR750	2007-00	—	YT12A-BS	—	—	
	GSXR750	1999-96	ETX9	YTX9-BS	—	—	
	GSXR750	1992-86	ETX15L	YTX14AHL-BS	YB14L-A2	12N14-3A	
	GSXR750W	1995-94	ETX9	YTX9-BS	—	—	
	GSXR750W	1993	ETX15L	YTX14AHL-BS	YB14L-A2	12N14-3A	
	GT750 Lemans	1977-72	ETX15L	YTX14AHL-BS	YB14L-A2	12N14-3A	
	VS750GLP Intruder	1991-88	ETX14{121}	—	YB16B-A1	—	
700cc	GS700E,ES	1985	ETX15L	YTX14AHL-BS	YB14L-A2	12N14-3A	
	GSX700E	1985	ETX15L	YTX14AHL-BS	YB14L-A2	12N14-3A	
	GV700GL Madura	1986-85	ETX15L	YTX14AHL-BS	YB14L-A2	12N14-3A	
	VS700GL Intruder	1987-85	ETX14{121}	—	YB16B-A1	—	
670cc	XN85 Turbo	1983	ETX15L	YTX14AHL-BS	YB14L-A2	12N14-3A	
650cc	DL650	2008-04	ETX12	YTX12-BS	—	—	
	DR650S	1993-92	—	YTX4L-BS	—	—	
	DR650S	1991-90	—	—	YB5L-B	12N5-3B	
	DR650SE	2008-97	ETX9	YTX9-BS	—	—	
	DR650SE	1996	—	—	YB10L-B2	—	
	DR650SE	1995-94	ETX12	YTX12-BS	—	—	
	GR650 Tempter,X	1984-83	ETX15L	YTX14AHL-BS	YB14L-A2	12N14-3A	
	GS650E	1982-81	—	—	YB10L-A2	—	
	GS650G,L,M	1983-81	ETX15L	YTX14AHL-BS	YB14L-A2	12N14-3A	
	GSX650F	2008	ETX9	YTX9-BS	—	—	
	LS650 Savage, S40	2007-86	ETX15L	YTX14AHL-BS	YB14L-B2	—	
	SV650	2008-03	ETX12	YTX12-BS	—	—	
	SV650	2002-99	—	YT12A-BS	—	—	
		XN85 Turbo	1984	ETX15L	YTX14AHL-BS	YB14L-A2	12N14-3A
	620cc	QUV620F	2006-05	ETX20L	YTX20L-BS	—	—
600cc	GSF600S Bandit	2002-01	ETX9	YTX9-BS	—	—	
	GSF600S Bandit	1999-95	ETX9	YTX9-BS	—	—	
	GSX600F Katana	1997-88	—	—	YB10L-B2	—	
	GSX600F, Katana	2006-98	ETX9	YTX9-BS	—	—	
	GSXR600,W	2007-97	ETX9	YTX9-BS	—	—	
	GSXR600,W	1993-92	ETX9	YTX9-BS	—	—	

MOTORCYCLES

MOTORCYCLES

APPLICATION DATA

CC	MODEL	YEAR	PREMIUM AGM Activated/ Ready to-install	STANDARD DRY		
				STANDARD AGM	LOW MAINTENANCE- HIGH PERFORMANCE	CONVENTIONAL
SUZUKI (Continued)						
600cc	RF600R	1996-94	ETX9	YTX9-BS	---	---
	SP600	1985	---	---	YB5L-B	12N5-3B
550cc	GS550E,ES,L	1986-79	---	---	YB10L-B	12N10-3B
	GS550E,L,M,TX	1986	---	---	YB10L-A2	---
	GS550E,L,M,TX	1982-77	---	---	YB10L-A2	---
	GT550 Indy	1977-72	---	---	---	12N11-3A-1
500cc	GS500,E	2007-89	---	---	YB10L-B2	---
	GT500 Titan	1977-76	---	---	YB7-A	12N7-4A
	SP500	1983-81	---	---	---	6N4B-2A
	T500 Titan	1975-68	---	---	YB7-A	12N7-4A
450cc	GS450	1988-83	ETX12{56}	YTX12-BS{56}	YB12B-B2	---
	GS450	1982-80	---	---	YB10L-A2	---
425cc	GS425E,L	1979	---	---	YB10L-A2	---
400cc	DRZ400/E/S	2008-00	---	YT7B-BS	---	---
	GN400T,X	1982-80	---	---	---	6N4B-2A
	GS400	1978-77	---	---	YB10L-A2	---
	GS400X	1978-77	---	---	YB7-A	12N7-4A
	GSF400 Bandit	1993-91	ETX9	YTX9-BS	---	---
	SP400	1980	---	---	---	6N4B-2A
	TS400 Apache	1977-76	---	---	---	6N4B-2A
	TS400 Apache	1975-72	---	---	YB5L-B	12N5-3B
380cc	GT380 Sebring	1977-72	---	---	YB7-A	12N7-4A
370cc	SP370	1979-78	---	---	---	6N4B-2A
350cc	DR350	1999-90	---	YTX4L-BS	---	---
	DR350S	1993-90	---	YTX4L-BS	---	---
	DR350SE	1999-94	---	YTX7L-BS	---	---
	T350 Rebel	1972-69	---	---	YB5L-B	12N5-3B
300cc	GS300L	1985	ETX12{56}	YTX12-BS{56}	YB12B-B2	---
	GS300L	1983-82	ETX12{56}	YTX12-BS{56}	YB12B-B2	---
250cc	DR250	1993-90	---	YTX7L-BS	---	---
	DR250	1985-82	---	YTX7L-BS	---	---
	DR250S	1992-90	---	YTX4L-BS	---	---
	DR250SE	1995-94	---	YTX7L-BS	---	---
	DRZ250	2007-01	---	YTX7S{61}	---	---
	GN250	1988-82	---	---	YB10L-A2	---
	GS250	1981-80	---	---	YB10L-A2	---
	GT250 Hustler	1977-73	---	---	YB5L-B	12N5-3B
	GZ250	2008-99	---	YTX7L-BS	---	---
	SP250	1984-82	---	---	---	6N4B-2A
	T250	1972-71	---	---	YB5L-B	12N5-3B
	TS250	1981-79	---	---	---	6N4B-2A
	TS250 Savage	1978-73	---	---	---	6N4B-2A
	TS250 Savage	1972-69	---	---	---	6N2-2A-4
200cc	DR200SE	2008-96	---	YTX7L-BS	---	---
	SP200	1988-85	---	---	YB4L-B	---
185cc	GT185 Adventurer	1977-73	---	---	---	12N11-3A-1
	TC185 Ranger	1977-74	---	---	---	12N11-3A-1
	TS185	1981-79	---	---	---	6N4B-2A
	TS185 Sierra	1978-71	---	---	---	6N4-2A
125cc	DR125	1988-82	---	---	YB7-A	12N7-4A
	DR125SE	1996-94	---	YTX7L-BS	---	---
	GN125	1997-91	---	---	YB7-A	12N7-4A
	GN125	1983-82	---	---	YB7-A	12N7-4A
	SP125	1988-86	---	---	---	6N4-2A
	SP125	1983-82	---	---	---	6N4B-2A
	TC125 Prospector	1977-72	---	---	---	6N4B-2A

{56} Hold-down modifications may be necessary. {61} Activated ready to install. {64} Top and front terminal mounts only.
 {65} Includes sensor not supplied with AGM. {75} Shipped with 17mm adapter.
 {115} Sensor NOT included with replacement battery. Disconnect sensor. Top and front terminal mounts only.
 {120} Shipped with 20mm adapter. Hold-down modifications may be necessary.

APPLICATION DATA

MOTORCYCLES

CC	MODEL	YEAR	PREMIUM AGM Activated/ Ready to-install	STANDARD DRY		
				STANDARD AGM	LOW MAINTENANCE- HIGH PERFORMANCE	CONVENTIONAL
SUZUKI (Continued)						
125cc	TS125 Duster	1981-71	---	---	---	6N4B-2A
120cc	TC120 Cat	1971-69	---	---	---	6N4B-2A
100cc	A100	1979-76	---	---	---	6N4-2A
	SP100	1984-83	---	---	---	6N4B-2A
	TC100 Blazer	1977-72	---	---	---	6N4B-2A
	TS100	1981-79	---	---	---	6N4B-2A
	TS100 Honcho	1978	---	---	---	6N4B-2A
	TS100 Honcho	1977-73	---	---	---	6N4-2A
90cc	RV90 Rover	1977-72	---	---	---	6N2-2A-4
	TC90 Blazer	1972-70	---	---	---	6N4-2A
70cc	DR-Z70	2008	---	YT4B-BS	---	---
50cc	F50 Cutlass	1971-70	---	---	---	6N4-2A
	OR50	1979	---	---	---	6N4B-2A
	OR51	1980	---	---	---	6N4B-2A
	TS50 Gaucho	1974	---	---	---	6N4-2A
YAMAHA						
1854cc	Roadliner, Stratoliner	2006	---	YT14B-4{61}	---	---
1700cc	XV1700 Road Star Warrior	2007-02	---	YT14B-4{61}	---	---
1600cc	XV1600 Road Star	2006-99	ETX20L	YTX20L-BS	---	---
1300cc	FJR1300	2007-03	---	YT14B-4{61}	---	---
	XVZ13 Royal Star	2007-96	ETX20L	YTX20L-BS	---	---
	XVZ13 Venture Royale	1993-86	ETX18L{115}	YTX24HL-BS{115}	SY50-N18L-AT{65}	---
1200cc	FJ1200	1993-91	ETX14{75}	YTX14-BS	---	---
	FJ1200	1990-86	ETX15L	YTX14AHL-BS	YB14L-A2	12N14-3A
	VMX12 V-Max	2007-85	---	---	YB16AL-A2	---
	XVZ12 Venture Royale	1985-83	ETX18L{64}	YTX24HL-BS{64}	Y50-N18L-A-LM	Y50-N18L-A
1100cc	FJ1100	1985-84	ETX15L	YTX14AHL-BS	YB14L-A2	12N14-3A
	XJ1100 Maxim	1982	ETX18L{64}	YTX24HL-BS{64}	Y50-N18L-A-LM	Y50-N18L-A
	XS1100	1983-78	ETX18L{64}	YTX24HL-BS{64}	Y50-N18L-A-LM	Y50-N18L-A
	XV1100 Virago	1999-86	ETX18L{64}	YTX24HL-BS{64}	Y50-N18L-A-LM	Y50-N18L-A
	XVS1100 V-Star	2007-99	---	YT14B-4{61}	---	---
1000cc	FZ1	2006-01	---	YT14B-4{61}	---	---
	FZR1000	1996-91	ETX14{75}	YTX14-BS	---	---
	FZR1000	1990-87	ETX15L	YTX14AHL-BS	YB14L-A2	12N14-3A
	FZS600 FZ1	2007-06	---	YTZ14S{61}	---	---
	GTS1000A	1994-93	ETX14{75}	YTX14-BS	---	---
	XV1000 Virago	1985-84	ETX18L{64}	YTX24HL-BS{64}	Y50-N18L-A-LM	Y50-N18L-A
	YZF1000R	1998-97	ETX14{75}	YTX14-BS	---	---
	YZFR1	2007-04	---	YTZ10S{61}	---	---
	YZFR1	2003-99	---	YT12B-BS{56}	---	---
920cc	XV920 Virago	1982	ETX18L{115}	YTX24HL-BS{115}	SY50-N18L-AT{65}	---
	XV920,R,M Virago	1983-81	ETX18L{64}	YTX24HL-BS{64}	Y50-N18L-A-LM	Y50-N18L-A
900cc	XJ900R Seca	1983	ETX15L	YTX14AHL-BS	YB14L-A2	12N14-3A
850cc	TDM850	1993-92	ETX12	YTX12-BS	---	---
	XS850	1981-80	ETX15L	YTX14AHL-BS	YB14L-A2	12N14-3A
750cc	FZ750	1988-85	ETX15L	YTX14AHL-BS	YB14L-A2	12N14-3A
	FZ750,R	1988-86	ETX15L	YTX14AHL-BS	YB14L-A2	12N14-3A
	TX750	1974-73	ETX16L{120}	YTX20L-BS	YB16L-B	12N16-3B
	XJ750 Maxim	1983-82	ETX15L{55}	---	SYB14L-A2{65}	---
	XJ750M Midnight Maxim	1983	ETX15L	YTX14AHL-BS	YB14L-A2	12N14-3A
	XJ750R Seca	1983-81	ETX15L	YTX14AHL-BS	YB14L-A2	12N14-3A
	XS750	1979-74	ETX15L	YTX14AHL-BS	YB14L-A2	12N14-3A
	XV750 Virago	1998-81	---	---	YB16AL-A2	---
	YZF750,R	1998-94	ETX12	YTX12-BS	---	---
700cc	FZ700 Fazer	1987-86	ETX15L	YTX14AHL-BS	YB14L-A2	12N14-3A
	FZX700 Fazer	1987-86	ETX15L	YTX14AHL-BS	YB14L-A2	12N14-3A
	XJ700X Maxim, X	1986-85	ETX15L	YTX14AHL-BS	YB14L-A2	12N14-3A
	XV700 Virago	1987-84	---	---	YB16AL-A2	---
650cc	TX650	1974	ETX15L	YTX14AHL-BS	YB14L-A2	12N14-3A
	TX650	1973	---	---	YB12A-A	12N12A-4A-1

MOTORCYCLES

MOTORCYCLES

APPLICATION DATA

CC	MODEL	YEAR	PREMIUM AGM Activated/ Ready to-install	STANDARD DRY		
				STANDARD AGM	LOW MAINTENANCE- HIGH PERFORMANCE	CONVENTIONAL
YAMAHA (Continued)						
650cc	XJ650 Maxim,Seca	1983-80	---	---	YB12A-A	12N12A-4A-1
	XS1	1982-81	---	---	YB12A-A	12N12A-4A-1
	XS1	1971-70	---	---	---	12N5.5-3B
	XS2	1983	---	---	YB12A-A	12N12A-4A-1
	XS2	1972	---	---	YB12A-A	12N12A-4A-1
	XS650	1983-75	ETX15L	YTX14AHL-BS	YB14L-A2	12N14-3A
	XVS650 V-Star	2006-98	---	YT12B-BS{56}	---	---
600cc	FJ600	1985-84	---	---	YB12A-A	12N12A-4A-1
	FZ6	2007-05	---	YT12B-BS{56}	---	---
	FZ600	1988-86	---	---	YB12A-A	12N12A-4A-1
	FZR600,R	1999-88	---	---	YB12AL-A	---
	SRX600	1986	---	---	YB5L-B	12N5-3B
	XJ600S Seca II	1999-92	ETX9	YTX9-BS	---	---
	XT600,E	1996-90	ETX9	YTX9-BS	---	---
	XT600,E	1989-84	---	---	YB5L-B	12N5-3B
	YX600 Radian	1990-86	---	---	YB12A-A	12N12A-4A-1
	YZF-R6	2000-99	---	YT12B-BS{56}	---	---
	YZF-R6(ex. R6S)	2007-06	---	YTZ10S{61}	---	---
	YZF-R6, R6S	2007-01	---	YT9B-4{61}	---	---
	YZF600R	2007-95	ETX12	YTX12-BS	---	---
550cc	XJ550 Maxim,Seca	1983-81	---	---	YB12A-A	12N12A-4A-1
	XT550	1983-82	---	---	YB5L-B	12N5-3B
	XZ550R Vision	1983-82	ETX15L	YTX14AHL-BS	YB14L-A2	12N14-3A
535cc	XV535 Virago	2001-93	---	---	YB12AL-A	---
	XV535 Virago	1990-87	---	---	YB12AL-A	---
500cc	SR500	1981-78	---	---	YB7L-B	12N7-3B
	TX500	1974-73	ETX15L	YTX14AHL-BS	YB14L-A2	12N14-3A
	XS500	1978-75	ETX15L	YTX14AHL-BS	YB14L-A2	12N14-3A
	XT500	1981-76	---	---	---	6N6-3B-1
	XV500	1983	---	---	YB12A-A	12N12A-4A-1
450cc	WR450	2007-03	---	YTZ7S{61}	---	---
400cc	DT400	1979-77	---	---	---	6N6-3B-1
	DT400	1976-75	---	---	---	6N4B-2A-3
	FZR400	1990-88	---	---	YB12AL-A	---
	RD400	1979-76	---	---	---	12N5.5A-3B
	WR400F	2003	---	YTZ7S{61}	---	---
	XS400	1983-80	---	---	YB12A-A	12N12A-4A-1
	XS400R Seca	1983-82	---	---	YB12A-A	12N12A-4A-1
	XS400S Special	1982-80	---	---	YB12A-A	12N12A-4A-1
360cc	DT360	1974	---	---	---	6N4B-2A-3
	RT1	1970	---	---	---	6N4-2A-5
	RT1B	1971	---	---	---	6N4-2A-5
	RT2,3	1972	---	---	---	6N4-2A-5
	RT2,5	1973	---	---	---	6N4-2A-5
	XS360C,D	1977-76	---	---	YB12A-A	12N12A-4A-1
	XS360C,D	1977	---	---	YB7L-B	12N7-3B
350cc	R3	1969	---	---	YB5L-B	12N5-3B
	R5B,C	1972-71	---	---	---	12N5.5A-3B
	RD350	1975-73	---	---	---	12N5.5A-3B
	RZ350	1985-83	---	---	---	12N5.5-3B
	XT350	1998-85	---	---	YB3L-B	---
	YR Grand Prix	1968-67	---	---	---	12N5.5-3B
	YR2C Scrambler	1968	---	---	---	12N5.5-3B
346cc	XT350	2000-99	---	---	YB3L-B	---
250cc	DS6 Street Scrambler	1971-69	---	---	YB5L-B	12N5-3B
	DS7	1972	---	---	---	12N5.5-3B
	DT1	1971-68	---	---	---	6N2-2A-3
	DT1MX	1971-70	---	---	---	6N2-2A-3
	DT2	1972	---	---	---	6N4-2A-5

{56} Hold-down modifications may be necessary. {61} Activated ready to install.

APPLICATION DATA

MOTORCYCLES

CC	MODEL	YEAR	PREMIUM AGM Activated/ Ready to-install	STANDARD DRY		
				STANDARD AGM	LOW MAINTENANCE- HIGH PERFORMANCE	CONVENTIONAL
YAMAHA (Continued)						
250cc	DT250	1979-77	---	---	---	6N6-3B-1
	DT250	1976-74	---	---	---	6N4B-2A-3
	DT3	1973	---	---	---	6N4-2A-5
	RD250	1975-73	---	---	---	12N5.5-3B
	SR250 Exciter	1982-80	---	---	YB12A-A	12N12A-4A-1
	SRX250	1988-87	---	---	YB12A-A	12N12A-4A-1
	TTR250	2006-99	---	YT7B-BS	---	---
	WR250F	2007-03	---	YTX5L-BS	---	---
	XT250	1984	---	---	YB3L-B	---
	XT250	1983-80	---	---	---	6N6-3B-1
	XV250 Route 66	1990-88	---	---	YB10L-A2	---
	XV250 Virago	2004-95	---	---	YB10L-A2	---
230cc	TTR230E	2007-06	---	YTX5L-BS	---	---
225cc	TTR225	2003-99	---	---	YB7B-B	---
	XT225	2006-01	---	YTZ7S{61}	---	---
	XT225	2000-92	---	YTX7L-BS	---	---
200cc	CS Series	1991-89	---	---	YB9L-A2	---
	CS Series	1972-70	---	---	YB9L-A2	---
	RD200	1978	---	---	YB9L-A2	---
	RD200	1976-74	---	---	YB9L-A2	---
	TW200 Trailway	2006	---	---	YB7C-A	---
	TW200 Trailway	2004-87	---	---	YB7C-A	---
	XT200	1983-82	---	---	---	6N4A-4D
185cc	SR185 Exciter	1982-81	---	---	YB7L-B	12N7-3B
180cc	YCS1	1968	---	---	YB9L-A2	---
175cc	CT1,B,C	1971-69	---	---	---	6N2-2A-3
	CT2,3,4,5	1974-72	---	---	---	6N4A-4D
	DT125	1974	---	---	---	6N4B-2A-3
	DT175	1981-77	---	---	---	6N6-3B-1
	DT175	1976-75	---	---	---	6N4B-2A-3
125cc	AS2C Twin Scrambler	1970	---	---	---	12N5.5-3B
	AT Series	1974-69	---	---	YB7L-B	12N7-3B
	DT100	1974	---	---	YB7L-B	12N7-3B
	DT125	1983	---	---	YB7L-B	12N7-3B
	DT125	1981-75	---	---	YB7L-B	12N7-3B
	RD125	1976-75	---	---	---	12N5.5A-3B
	TTR125	2006-03	---	YTX4L-BS	---	---
	XT125	1984-82	---	---	---	6N4A-4D
	YA6	1966-64	---	---	YB10L-B	12N10-3B
	YAS1C Scrambler Twin	1968	---	---	---	12N5.5-3B
100cc	DT100	1983-77	---	---	---	6N4-2A-5
	DT100	1976-74	---	---	---	6N4B-2A-3
	L5T	1969	---	---	YB7L-B	12N7-3B
	LS2	1972	---	---	---	12N5.5-3B
	LT2	1972	---	---	---	6N4A-4D
	LT3	1973	---	---	---	6N4A-4D
	RS100	1976-75	---	---	---	6N4A-4D
	YL1,2 TwinJet	1968	---	---	YB7L-B	12N7-3B
90cc	HS1	1990	---	---	---	12N5.5-3B
	HS1	1971	---	---	---	12N5.5-3B
	HT1	1971-70	---	---	---	6N2-2A-3
	TTR90E	2006-03	---	YT4B-BS	---	---
80cc	DT80	1983-81	---	---	---	6N4-2A-5
	G Series	1980-73	---	---	---	6N4-2A-5
	G Series	1972-70	---	---	---	6N4A-4D
	YG5T	1969-68	---	---	YB7L-B	12N7-3B
60cc	RD60	1975-73	---	---	---	6N4A-4D
50cc	DT50	1990-88	---	---	---	6N4B-2A-3
	TTR50E	2006	---	YT4B-BS	---	---
	YSR50	1992-87	---	---	---	6N4-2A-5

MOTORCYCLES

CC	MODEL	YEAR	PREMIUM AGM Activated/ Ready to-install	STANDARD DRY		
				STANDARD AGM	LOW MAINTENANCE- HIGH PERFORMANCE	CONVENTIONAL
APRILIA						
1000cc	ETV 1000 Capo Nordo	2003-02	ETX14{75}	YTX14-BS	---	---
	RST Futura	2004-01	ETX12	YTX12-BS	---	---
	RSV 1000 Factory	2005-04	ETX12	YTX12-BS	---	---
	RSV Mille,R,SP	2005-00	ETX12	YTX12-BS	---	---
	SL 1000 Falco	2003-00	ETX14{75}	YTX14-BS	---	---
	Tuono	2005-03	ETX12	YTX12-BS	---	---
650cc	Pegaso 650	1999-92	ETX15L	YTX14AHL-BS	YB14L-A2	12N14-3A
	Pegaso 650 (MX)	2003-00	---	---	YB12AL-A	---
600cc	Pegaso 600	1998-90	---	---	YB12AL-A	---
	Tuareg 600 Wind	1988-87	ETX15L	YTX14AHL-BS	YB14L-A2	12N14-3A
500cc	Atlantic 500	2005-02	ETX15L	YTX14AHL-BS	YB14L-A2	12N14-3A
	Scarabeo	2005-04	---	---	YB4L-B	---
349cc	EXT 350	1998-85	ETX15L	YTX14AHL-BS	YB14L-A2	12N14-3A
	Tuareg 350	1998-87	ETX15L	YTX14AHL-BS	YB14L-A2	12N14-3A
	Wind	1987	ETX15L	YTX14AHL-BS	YB14L-A2	12N14-3A
320cc	TL 320	1986	---	---	YB9-B	12N9-4B-1
250cc	RS250	2005-95	---	---	YB4L-B	---
200cc	Atlantic	2005-04	---	---	YB12AL-A	---
150cc	Leonardo 150	2005-00	---	---	YB12AL-A	---
	Mojito	2005-04	---	YTX7L-BS	---	---
	Scarabeo 150	2004-00	---	---	YB12AL-A	---
125cc	AF1 125 Replica 89	1998-87	---	---	YB9-B	12N9-4B-1
	AF1 125 Sintesi	1998-88	---	---	YB9-B	12N9-4B-1
	AF1 Futura,Sport	1998-90	---	---	YB9-B	12N9-4B-1
	Europa, ETX 125	1998-84	---	---	YB9-B	12N9-4B-1
	RS,RX 125 Extrema/Replica	1998-90	---	---	YB9-B	12N9-4B-1
	Red Rose 125	1998-88	---	---	YB9-B	12N9-4B-1
	ST,STX 125	1998-82	---	---	YB9-B	12N9-4B-1
	Tuareg	1998-86	---	---	YB9-B	12N9-4B-1
50cc	AF1 50	1998-86	---	---	YB4L-B	---
	ET 50 AE,Fire	1998-87	---	---	YB4L-B	---
	GL 50	1998-93	---	---	YB4L-B	---
	Mojito	2005-04	---	---	YB4L-B	---
	RS 50 Extrema,Replica	2005-00	---	---	YB4L-B	---
	RX 50	1998-90	---	---	YB4L-B	---
	Rally	2005-04	---	---	YB4L-B	---
	Red Rose 50	1998-87	---	---	YB4L-B	---
	SR 50 Ditech	2005-01	---	YTX5L-BS	---	---
	SR 50 Racing	2001-00	---	---	YB4L-B	---
	Scarabeo 50	2003-93	---	---	YB4L-B	---
	Tuareg 50	1998-87	---	---	YB4L-B	---
BMW						
1200cc	K1200GT,LT,RS	2005-97	---	---	51913	---
	R1200C	2003-98	---	---	51913	---
	R1200GS	2005	ETX14{75}	YTX14-BS	---	---
1150cc	R1150GS	2001-00	---	---	51913	---
1100cc	K1100LT,GS,RS	1999-93	---	---	51913	---
	R1100R,S,T	2003-95	---	---	51913	---
1000cc	R100GS/PD,RT	1995-94	ETX16L{118}	---	53030	---
900cc	R90/6,S	1976-74	ETX16L{118}	---	53030	---
850cc	R850R	1999-96	---	---	51913	---
750cc	K75	1995-94	ETX16L{118}	---	53030	---
650cc	F650	2003-97	---	---	YB12AL-A	---

{56} Hold-down modifications may be necessary.

{66} The YTX20 series batteries may be used as an optional upgrade. See battery label for retrofit cautions.

{75} Shipped with 17mm adapter. {118} Shipped with 20mm adapter.Top and front terminal mounts only.

{120} Shipped with 20mm adapter. Hold-down modifications may be necessary.

{121} Shipped with 17mm adapter.Hold-down modifications may be necessary.

APPLICATION DATA

EUROPEAN MOTORCYCLES

CC	MODEL	YEAR	PREMIUM AGM Activated/ Ready to-install	STANDARD DRY		
				STANDARD AGM	LOW MAINTENANCE- HIGH PERFORMANCE	CONVENTIONAL
CAGIVA						
900cc	Elefant E900		ETX14{121}	—	YB16B-A1	—
750cc	Elefant	1997-94	ETX16{120}	YTX20-BS{66}	YB16-B-LM	YB16-B
500cc	T4 E Elefant	1988	ETX15L	YTX14AHL-BS	YB14L-B2	—
350cc	Elefant 2 Cyl.	1986	ETX15L	YTX14AHL-BS	YB14L-B2	—
125cc	Crouser	1988-87	—	—	YB9-B	12N9-4B-1
	Lucky	1996	—	YTX4L-BS	—	—
	City	1997-94	—	YTX4L-BS	—	—
	Elefant Bifaro	1989	ETX15L	YTX14AHL-BS	YB14L-B2	—
	Explorer	1997-94	—	YTX4L-BS	—	—
	Freccia	1990-87	—	—	YB9-B	12N9-4B-1
	K3	1998	—	—	YB4L-B	—
	Lucky	1997	—	YTX4L-BS	—	—
	Lucky	1995-94	—	YTX4L-BS	—	—
	Mito	1997-90	—	—	YB9-B	12N9-4B-1
	N 90	1997	—	—	YB9-B	12N9-4B-1
	Roadster	1997-94	—	—	YB9-B	12N9-4B-1
	Supercity	1997	—	—	YB9-B	12N9-4B-1
	T4 E Elefant	1987	ETX15L	YTX14AHL-BS	YB14L-B2	—
	T4R	1987	—	—	YB3L-A	—
	W4	1998	—	—	YB4L-B	—
CCM						
600cc	All Electric Start	2001-96	ETX9	YTX9-BS	—	—
DRR						
ALL	All Models	ALL	—	YTX4L-BS	—	—
DUCATI						
1200cc	12 S Multistrada	2007	—	YT12B-BS{56}	—	—
1100cc	1100, S Hypermotard,Multistrada	2007	—	YT12B-BS{56}	—	—
1098cc	1098	2007	—	YT12B-BS{56}	—	—
999cc	998	2002	—	YT12B-BS{56}	—	—
	998,999	2007-03	—	YT12B-BS{56}	—	—
996cc	916	2000-98	—	—	YB16AL-A2	—
	996	2007-01	—	YT12B-BS{56}	—	—
	996	2000-99	—	—	YB16AL-A2	—
	Sport Touring 4 (ST4)	2007-02	—	YT12B-BS{56}	—	—
944cc	Sport Touring 2 (ST2)	2007-01	—	YT12B-BS{56}	—	—
	Sport Touring 2 (ST2)	2000-98	—	—	YB16AL-A2	—
916cc	916	1998-94	—	—	YB16AL-A2	—
	Sport Touring 4 (ST4)	2002-01	—	YT12B-BS{56}	—	—
	Sport Touring 4 (ST4)	2000-99	—	—	YB16AL-A2	—
900cc	900 Monster,SD,SP,SS	2000-91	—	—	YB16AL-A2	—
	900 Monster,SD,SP,SS	1982-79	—	—	YB16AL-A2	—
	900 Monster,SS	2007-01	—	YT12B-BS{56}	—	—
	900 Monster,SS	1998-94	—	YT12B-BS{56}	—	—
	900 SS	1981	—	—	YB12A-A	12N12A-4A-1
	I.E.,Paso	1995-90	ETX16{120}	YTX20-BS{66}	YB16-B-LM	YB16-B
888cc	888 LTD,SPO	1994-93	—	—	YB16AL-A2	—
	888 Superbike	1992-90	—	—	YB16AL-A2	—
860cc	860 GS,GTS	1980-78	ETX16L{118}	—	53030	—
850cc	851 Sport	1992-90	—	—	YB16AL-A2	—
800cc	800SS	2007	—	YT12B-BS{56}	—	—
750cc	750 F1,Paso	1998-97	ETX15L	YTX14AHL-BS	YB14L-A2	12N14-3A
	750 F1,Paso	1988-85	ETX15L	YTX14AHL-BS	YB14L-A2	12N14-3A
	750 Monster,SS	2007-01	—	YT12B-BS{56}	—	—
	750 Monster,SS	2000-97	—	—	YB16AL-A2	—
	750 Monster,SS	1993-90	—	—	YB16AL-A2	—
	750 Monster,SS	1974-72	—	—	YB16AL-A2	—
748cc	748, R	2000-97	—	—	YB16AL-A2	—
	748,Monoposto,Biposto, S, R	2007-01	—	YT12B-BS{56}	—	—

CC	MODEL	YEAR	PREMIUM AGM Activated/ Ready to-install	STANDARD DRY		
				STANDARD AGM	LOW MAINTENANCE- HIGH PERFORMANCE	CONVENTIONAL
DUCATI (Continued)						
695cc	Multistrada	2007	---	YT12B-BS{56}	---	---
650cc	650 Indiana	1987	ETX15L	YTX14AHL-BS	YB14L-A2	12N14-3A
620cc	620 Monster	2003-02	---	YT12B-BS{56}	---	---
600cc	600 Monster	2007-01	---	YT12B-BS{56}	---	---
	600 Monster	2000	ETX15L	YTX14AHL-BS	YB14L-A2	12N14-3A
	600 SL Pantha	1984-81	ETX15L	YTX14AHL-BS	YB14L-A2	12N14-3A
500cc	500 SL Pantha	1981	ETX15L	YTX14AHL-BS	YB14L-A2	12N14-3A
GAS GAS						
338cc	Pampera 320	2003-98	---	YTX4L-BS	---	---
	Pampera 370	1997	---	YTX4L-BS	---	---
250cc	Pampera PP250	2003-96	---	YTX4L-BS	---	---
GILERA						
600cc	RC 600C	1993	ETX15L	YTX14AHL-BS	YB14L-A2	12N14-3A
	Top Rally, XRT		ETX15L	YTX14AHL-BS	YB14L-A2	12N14-3A
	XRT		ETX15L	YTX14AHL-BS	YB14L-A2	12N14-3A
350cc	Dakota - Kick Start		---	---	---	12N5.5-3B
	Dakota - Electric Start		---	---	YB10L-A2	---
	ER - Electric Start		---	---	YB10L-A2	---
	Nordwest	1993	ETX15L	YTX14AHL-BS	YB14L-A2	12N14-3A
250cc	Arizona Rally		---	---	YB10L-B	12N10-3B
	RV NGR - Kick Start		---	---	---	12N5.5-3B
	RV NGR - Electric Start		---	---	YB10L-B	12N10-3B
200cc	ER - Kick Start		---	---	---	12N5.5-3B
	Fast Bike - Kick Start		---	---	---	12N5.5-3B
	Fast Bike - Electric Start		---	---	YB9-B	12N9-4B-1
	Motocarro		---	---	---	B38-6A
	T4		---	---	---	12N5.5-3B
125cc	Apache - Kick Start		---	---	---	12N5.5-3B
	Apache - Electric Start		---	---	YB9-B	12N9-4B-1
	Arizona		---	---	YB9-B	12N9-4B-1
	Arizona		---	---	---	12N5.5-3B
	Arizona - Kick Start		---	---	---	12N5.5-3B
	Arizona - Electric Start		---	---	YB9-B	12N9-4B-1
	CX - Kick Start		---	---	---	12N5.5-3B
	CX - Electric Start		---	---	YB9-B	12N9-4B-1
	Crona - Kick Start		---	---	---	12N5.5-3B
	Crona - Electric Start		---	---	YB9-B	12N9-4B-1
	Fast Bike		---	---	---	12N5.5-3B
	Freestyle - Kick Start		---	---	---	12N5.5-3B
	Freestyle - Electric Start		---	---	YB9-B	12N9-4B-1
	GFR - Kick Start		---	---	---	12N5.5-3B
	GFR - Electric Start		---	---	YB9-B	12N9-4B-1
	KK, KZ - Kick Start		---	---	---	12N5.5-3B
	KK, KZ - Electric Start		---	---	YB9-B	12N9-4B-1
	MX1, MXR - Kick Start		---	---	---	12N5.5-3B
	MX1, MXR - Electric Start		---	---	YB9-B	12N9-4B-1
	Nebraska - Kick Start		---	---	---	12N5.5-3B
	Nebraska - Electric Start		---	---	YB9-B	12N9-4B-1
	R1, R1S - Kick Start		---	---	---	12N5.5-3B
	R1, R1S - Electric Start		---	---	YB9-B	12N9-4B-1
	RC Rally		---	---	YB10L-B	12N10-3B
	RTX, RV, RX - Kick Start		---	---	---	12N5.5-3B
	RTX, RV, RX - Electric Start		---	---	YB9-B	12N9-4B-1
	Stalker		---	---	YB4L-B	---
	TOP Rally - Kick Start		---	---	---	12N5.5-3B
	TOP Rally - Electric Start		---	---	YB9-B	12N9-4B-1
	Typhoon		---	---	YB7-A	12N7-4A

{56} Hold-down modifications may be necessary. {64} Top and front terminal mounts only.

{66} The YTX20 series batteries may be used as an optional upgrade. See battery label for retrofit cautions. {75} Shipped with 17mm adapter.

{118} Shipped with 20mm adapter. Top and front terminal mounts only. {120} Shipped with 20mm adapter. Hold-down modifications may be necessary.

APPLICATION DATA

EUROPEAN MOTORCYCLES

CC	MODEL	YEAR	PREMIUM AGM Activated/ Ready to-install	STANDARD DRY		
				STANDARD AGM	LOW MAINTENANCE- HIGH PERFORMANCE	CONVENTIONAL
GILERA						
125cc	XR1, XR2 - Kick Start		---	---	---	12N5.5-3B
	XR1, XR2 - Electric Start		---	---	YB9-B	12N9-4B-1
50cc	Easy Moving	1997	---	---	YB4L-B	---
	Runner	1997	---	---	YB4L-B	---
	Bullit	1997	---	---	YB4L-B	---
	Eaglet	1997-95	---	---	YB4L-B	---
	GSA - Electric Start		---	---	YB4L-B	---
	Runner	1997	---	---	YB4L-B	---
	SPO1, SPO2 - Kick Start		---	---	---	12N5.5-3B
	SPO1, SPO2 - Electric Start		---	---	YB9-B	12N9-4B-1
	Sioux - Electric Start		---	---	YB4L-B	---
	Typhoon	1997	---	---	YB4L-B	---
HUSABERG						
650cc	All (Electric Start)Models	2003-01	---	YTX5L-BS	---	---
600cc	All (Electric Start)Models	2000-97	---	---	YB9-B	12N9-4B-1
	FC600	1992	ETX9	YTX9-BS	---	---
550cc	All (Electric Start)Models	2003-01	---	YTX5L-BS	---	---
500cc	All (Electric Start)Models	2003-01	---	YTX5L-BS	---	---
	All (Electric Start)Models	2000-97	---	---	YB9-B	12N9-4B-1
	FC,FE501	1996-90	---	---	YB9-B	12N9-4B-1
499cc	FC499	1992	ETX9	YTX9-BS	---	---
470cc	All (Electric Start)Models	2002-01	---	YTX5L-BS	---	---
400cc	All (Electric Start)Models	2003-01	---	YTX5L-BS	---	---
	All (Electric Start)Models	2000-97	---	---	YB9-B	12N9-4B-1
	FC400	2000-97	ETX9	YTX9-BS	---	---
HUSQVARNA						
610cc	SM 610 S Supermotard	2002-99	ETX14{75}	YTX14-BS	---	---
	TE610	2002-98	ETX14{75}	YTX14-BS	---	---
400cc	400 TE	2002-01	ETX14{75}	YTX14-BS	---	---
INDIAN						
1650cc	Chief	2003-02	ETX18L{64}	YTX24HL-BS{64}	Y50-N18L-A-LM	Y50-N18L-A
1450cc	Scout,Spirit	2003-02	ETX16{120}	YTX20-BS{66}	YB16-B-LM	YB16-B
ITAL JET						
50cc	All Models	1984-82	---	---	YB4L-B	---
KTM						
640cc	640 LC4 Adventure Rally	2002-99	ETX9	YTX9-BS	---	---
	640 LC4 Dual	2002-00	ETX9	YTX9-BS	---	---
	640 LC4 Duke II	2002-99	ETX9	YTX9-BS	---	---
	640 LC4 Super Moto	2002-00	ETX9	YTX9-BS	---	---
620cc	620 LC4	1998-94	ETX9	YTX9-BS	---	---
	620 SC Rally Adventure	1998-94	ETX9	YTX9-BS	---	---
	Duke 620e	1997-95	ETX9	YTX9-BS	---	---
520cc	520 EXC	2002-00	---	YTX4L-BS	---	---
	520 MXC	2002-00	---	YTX4L-BS	---	---
400cc	400 EXC	2002-00	---	YTX4L-BS	---	---
	400 EXC	1998-94	---	YTX4L-BS	---	---
	400 LC4 EXC	2002-96	ETX9	YTX9-BS	---	---
	400 LC4 RXC	1999-94	ETX9	YTX9-BS	---	---
	400 LC4 SXC	2002-00	ETX9	YTX9-BS	---	---
125cc	LC2 125	1998	---	YTX4L-BS	---	---
	Sting 125	1998	---	YTX4L-BS	---	---
LAVERDA						
1200cc	Mirage	1982	ETX16L{118}	---	53030	---
	TS Mirage	1984-83	ETX16L{118}	---	53030	---
1000cc	Corsa	1984	ETX16L{118}	---	53030	---
	Jota	1984-82	ETX16L{118}	---	53030	---

CC	MODEL	YEAR	PREMIUM AGM Activated/ Ready to-install	STANDARD DRY		
				STANDARD AGM	LOW MAINTENANCE- HIGH PERFORMANCE	CONVENTIONAL
MAICO						
500cc	GS500	1996-92	---	---	---	B39-6
MOTO GUZZI						
1100cc	Bassa	2000-94	---	---	53030	---
	California 1100 - California	2005-03	---	YTX15L-BS	---	---
	California 1100,Jackal,Special,EV	2005-94	---	---	53030	---
	Quota 1000ES	2002-00	---	YTX15L-BS	---	---
	Sport 1100	1997-95	---	YTX15L-BS	---	---
	V11 LeMans	2005-99	---	YTX15L-BS	---	---
	V11 Sport	2005-98	---	YTX15L-BS	---	---
1000cc	Daytona	1997-93	ETX16L{118}	---	53030	---
	V10 Centauro	1999	---	YTX15L-BS	---	---
850cc	850 T5	1985-84	ETX16L{118}	---	53030	---
	LeMans III	1984-83	ETX16L{118}	---	53030	---
750cc	Breva	2005-04	ETX15L	YTX14AHL-BS	YB14L-A2	12N14-3A
	V-75	1987-86	ETX20L{56}	YTX20L-BS{66}	YB18L-A	---
500cc	V-50 II	1982-80	ETX16L{118}	---	53030	---
MOTO MORINI						
500cc	500 Camel,Special, Sport	1985-82	ETX20L{56}	YTX20L-BS{66}	YB18L-A	---
350cc	350 Kangaru	1985-83	ETX20L{56}	YTX20L-BS{66}	YB18L-A	---
MOTO-SKI						
500cc	Futura 500	1980	ETX15L	YTX14AHL-BS	YB14L-A2	12N14-3A
	Grand Prix Special	1980	ETX15L	YTX14AHL-BS	YB14L-A2	12N14-3A
464cc	Futura LC	1980	ETX15L	YTX14AHL-BS	YB14L-A2	12N14-3A
440cc	Ultra Sonic	1980	ETX15L	YTX14AHL-BS	YB14L-A2	12N14-3A
MZ						
660cc	Skorpion Sport,Tour	1998-95	---	---	YB7L-B	12N7-3B
500cc	Saxon Country,Tour,Silver Star	1998-95	ETX15L	YTX14AHL-BS	YB14L-A2	12N14-3A
NORTON						
850cc	850 Commando		ETX15L	YTX14AHL-BS	YB14L-A2	12N14-3A
750cc	750 Ranger Commando		---	---	YB9-B	12N9-4B-1
350cc	350 Navigator		---	---	---	6N11A-1B
PANDA						
70cc	Trailrider	2003-00	---	YTX4L-BS	---	---
50cc	Comute	2001-97	---	---	---	6N2-2A
	Cub	2000-97	---	YTX4L-BS	---	---
	Funrider	2003-96	---	---	---	6N2-2A
	Retro	2002-01	---	---	YB7-A	12N7-4A
PIAGGIO (VESPA)						
	APE CAR,MP		ETX16L{118}	---	53030	---
	Ape 50 FL	1993	---	---	YB9-B	12N9-4B-1
	Boxer, Bravo, Ciao		---	---	---	B39-6
	Cosa 2		---	---	YB7-A	12N7-4A
	Cosa CLX 125		---	---	YB7-A	12N7-4A
	Cosa CLX 150		---	---	YB7-A	12N7-4A
	Cosa CLX 200		---	---	YB7-A	12N7-4A
	Free		---	---	YB4L-B	---
	Hexagon 125/150		---	---	YB9-B	12N9-4B-1
	NRG 50		---	---	YB4L-B	---
	P125		---	---	YB7-A	12N7-4A
	P200E		---	---	YB9-B	12N9-4B-1
	P80X,KP80		---	---	---	12N5.5-3B
	PK50		---	---	YB7-A	12N7-4A
	PK80S-C.A.		---	---	YB7-A	12N7-4A
	PX 125		---	---	YB9-B	12N9-4B-1
	PX150E		---	---	YB9-B	12N9-4B-1
	PX200		---	---	YB9-B	12N9-4B-1

{56} Hold-down modifications may be necessary.

{66} The YTX20 series batteries may be used as an optional upgrade. See battery label for retrofit cautions.

{75} Shipped with 17mm adapter. {118} Shipped with 20mm adapter.Top and front terminal mounts only.

APPLICATION DATA

EUROPEAN MOTORCYCLES

CC	MODEL	YEAR	PREMIUM AGM Activated/ Ready to-install	STANDARD DRY		
				STANDARD AGM	LOW MAINTENANCE- HIGH PERFORMANCE	CONVENTIONAL
PIAGGIO (VESPA) (Continued)						
	PX200E-ARC		---	---	---	12N5.5-3B
	Skipper 125/150		---	---	YB4L-B	---
	Vespa 125 Sprint		---	---	---	B39-6
	Vespa 50 Elestart		---	---	---	6N11A-1B
	Vespa PK 50 FL/FL2 (c/av.)		---	---	YB7-A	12N7-4A
	Vespa150 GL		---	---	---	B39-6
	Zip - Zip (Fast Rider)		---	---	YB4L-B	---
PUCH						
80cc	Cobra 80,GTL		---	---	---	B39-6
50cc	Daytona N50		---	---	---	B39-6
	Lido		---	---	YB4L-B	---
	Monza		---	---	---	B39-6
ROYAL ENFIELD						
500cc	All(Kick Start)Models - Kick Start	2003-00	---	---	YB5L-B	12N5-3B
	All Models - Kick Start	1999-95	---	---	YB7-A	12N7-4A
	All Models - Electric Start	2003-00	ETX15L	YTX14AHL-BS	YB14L-A2	12N14-3A
	All(Electric Start)Models - Electric Start	2003	ETX15L	YTX14-BS	---	---
	Bullet	2001-95	---	---	YB7-A	12N7-4A
TRIUMPH						
2300cc	Rocket 3	2007-03	ETX20L	YTX20L-BS	---	---
1200cc	Daytona 1200	1999	ETX15L	YTX14AHL-BS	YB14L-A2	12N14-3A
	Daytona 1200	1997-93	ETX15L	YTX14AHL-BS	YB14L-A2	12N14-3A
	Trophy 1200	2002-91	ETX14{75}	YTX14-BS	---	---
1050cc	Sprint ST, Speed Triple	2007-05	---	YT12A-BS	---	---
	Tiger	2007	---	YT12B-BS{56}	---	---
955cc	Daytona 955i	2001-97	ETX14{75}	YTX14-BS	---	---
	Speed Triple	2002-98	ETX14{75}	YTX14-BS	---	---
	Sprint RS,ST	2002-99	ETX14{75}	YTX14-BS	---	---
	Tiger	2002-01	ETX14{75}	YTX14-BS	---	---
900cc	Scrambler, Bonneville	2007-06	ETX12	YTX12-BS	---	---
	Thrupton	2007-03	ETX12	YTX12-BS	---	---
885cc	Daytona, Legend, Adventurer	2001-93	ETX15L	YTX14AHL-BS	YB14L-A2	12N14-3A
	Speed,Sprint,SS	1999-93	ETX15L	YTX14AHL-BS	YB14L-A2	12N14-3A
	Thunderbird,Trident, Trophy	2003-91	ETX15L	YTX14AHL-BS	YB14L-A2	12N14-3A
	Tiger	2001-93	ETX14{75}	YTX14-BS	---	---
790cc	Bonneville	2003-01	ETX12	YTX12-BS	---	---
	Speedmaster	2005-03	ETX12	YTX12-BS	---	---
750cc	Bonneville T140E,ES	1982-79	---	---	YB9-B	12N9-4B-1
	Royal T140ES	1982	ETX15L	YTX14AHL-BS	YB14L-A2	12N14-3A
	Trident 750	1998-95	ETX15L	YTX14AHL-BS	YB14L-A2	12N14-3A
675cc	Daytona 675	2007-06	---	YT7B-BS	---	---
650cc	6T - w/6 Volt		---	---	---	6N11A-1B
	BonnevilleT120		---	---	YB7L-B	12N7-3B
	T20B - w/6 Volt		---	---	---	6N11A-1B
600cc	600 - w/12 Volt, Two batteries required. For best result		---	---	---	B39-6
	Daytona	2005-03	ETX9	YTX9-BS	---	---
	Speed Triple	2003	ETX12	YTX12-BS	---	---
	TT600	2003-00	ETX12	YTX12-BS	---	---
500cc	500 - w/12 Volt, Two batteries required. For best result		---	---	---	B39-6
	5T - w/6 Volt		---	---	---	6N11A-1B
350cc	350 - w/12 Volt, Two batteries required. For best result		---	---	---	B39-6
	350 - w/6 Volt		---	---	---	6N11A-1B
	3TA - w/6 Volt		---	---	---	B38-6A

EUROPEAN

CC	MODEL	YEAR	PREMIUM AGM Activated/ Ready to-install	STANDARD DRY		
				STANDARD AGM	LOW MAINTENANCE- HIGH PERFORMANCE	CONVENTIONAL
TRIUMPH (Continued)						
250cc	Tigress - w/12 Volt, Two batteries required. For best result		---	---	---	6N11A-1B
250cc	Tigress - w/6 Volt		---	---	---	6N11A-1B
200cc	Tiger - w/6 Volt		---	---	---	6N11A-1B
173cc	Tiger - w/6 Volt		---	---	---	6N11A-1B
150cc	Trident		---	---	YB7L-B	12N7-3B
125cc	Bonneville		---	---	YB7L-B	12N7-3B

- {61} Activated ready to install. {64} Top and front terminal mounts only.
- {71} Height with 20mm spacer included for use in replacing YB16CL-B.
- {72} Includes 10mm spacer for additional height required in replacing YB14A-A1 and YB14A-A2.
- {75} Shipped with 17mm adapter. {76} Shipped with 10mm adapter.
- {120} Shipped with 20mm adapter. Hold-down modifications may be necessary.
- {122} Shipped with 10mm adapter. Hold-down modifications may be necessary.

EUROPEAN

CC	MODEL	YEAR	PREMIUM AGM Activated/ Ready to-install	STANDARD DRY		
				STANDARD AGM	LOW MAINTENANCE-HIGH PERFORMANCE	CONVENTIONAL
AEON (BENZA)						
100cc	Cobra/CX-Sport 100	ALL	---	YTX4L-BS	---	---
90cc	Cobra/CX-Sport 90	ALL	---	YTX4L-BS	---	---
50cc	Cobra/CX-Sport 50	ALL	---	YTX4L-BS	---	---
ARCTIC CAT						
650cc	All 650 Models	2006-04	ETX15{76}	YTX14AH-BS	YB14-A2	---
500cc	All 500 Models	2005-04	ETX15{76}	YTX14AH-BS	YB14-A2	---
400cc	All 400 Models	2005-04	ETX15{76}	YTX14AH-BS	YB14-A2	---
	DVX-Sport	2006-04	ETX9	YTX9-BS	---	---
300cc	All 300 Models	2006-04	ETX15L	YTX14AHL-BS	YB14L-A2	12N14-3A
250cc	All 250 Models	2005-04	ETX15L	YTX14AHL-BS	YB14L-A2	12N14-3A
	DVX250	2006	ETX12	YTX12-BS	---	---
90cc	DVX90	2006	---	YTX5L-BS	---	---
	DVX90	2005-04	---	YTX4L-BS	---	---
50cc	DVX50	2006-04	---	YTX5L-BS	---	---
BOMBARDIER						
800cc	Outlander EFI	2007-06	ETX20L	YTX20L-BS	---	---
660cc	Outlander EFI	2006	ETX20L	YTX20L-BS	---	---
650cc	DS650	2006-00	---	YTX15L-BS	---	---
	Quest	2005-02	ETX16L{120}	YTX20HL-BS-PW{71}	YB16CL-B	---
	Quest - Optional	2005-02	ETX18L{64}	YTX24HL-BS{64}	Y50-N18L-A-LM	Y50-N18L-A
500cc	Quest	2005-99	ETX16L{120}	YTX20HL-BS-PW{71}	YB16CL-B	---
	Quest - Optional	2005-02	ETX18L{64}	YTX24HL-BS{64}	Y50-N18L-A-LM	Y50-N18L-A
	Traxter	2005-99	ETX16L{120}	YTX20HL-BS-PW{71}	YB16CL-B	---
	Traxter - Optional	2005-02	ETX18L{64}	YTX24HL-BS{64}	Y50-N18L-A-LM	Y50-N18L-A
400cc	Outlander	2004-03	---	YTX15L-BS	---	---
	Outlander,XT	2005-04	ETX20L	YTX20L-BS	---	---
330cc	Outlander	2005-04	---	YTX15L-BS	---	---
250cc	DS250	2006	ETX12	YTX12-BS	---	---
200cc	Rally	2006-03	ETX15{122}	YTX14AH-BS{72}	YB14A-A2	---
90cc	DS90,F,Quest	2006-02	---	YTX4L-BS	---	---
50cc	DS50,Quest	2006-02	---	YTX4L-BS	---	---
CANNONDALE						
432cc	All Models	2003-01	ETX9	YTX9-BS	---	---
E-TON						
150cc	CXL150 Yukon II	2003-02	ETX9	YTX9-BS	---	---
	YXL150 Yukon	2001-00	ETX9	YTX9-BS	---	---
90cc	AXL,NXL,RXL,TXL	2003-99	---	YTX4L-BS	---	---
	DXL90 Sierra	2003-00	---	YTX5L-BS	---	---
50cc	AXL,NXL,RXL,TXL	2003-99	---	YTX4L-BS	---	---
HONDA						
680cc	TRX680 FourTrax Rincon	2007-06	ETX20L	YTX20L-BS	---	---
650cc	TRX650FourTrax Rincon	2005-03	ETX14{75}	YTX14-BS	---	---
	TRX650FourTrax Rincon - Optional	2004-03	ETX20L	YTX20L-BS	---	---
500cc	TRX500 Foreman, Rubicon,FE,FM,TM	2008-01	ETX14{75}	YTX14-BS	---	---
450cc	TRX450FourTrax, Foreman, ES	2004-98	ETX14{75}	YTX14-BS	---	---
	TRX450R	2008-06	---	YTZ7S{61}	---	---
420cc	TRX420 Rancher	2007	ETX14{75}	YTX14-BS	---	---
400cc	FL400R Pilot	1990-89	ETX14{75}	YTX14-BS	---	---
	TRX400EX, FourTrax,Sportrax	2007-99	ETX9	YTX9-BS	---	---
	TRX400FW Foreman	2003-95	ETX14{75}	YTX14-BS	---	---
	TRX400Rancher AT	2007-04	ETX14{75}	YTX14-BS	---	---
350cc	FL350R Odyssey	1985	ETX12	YTX12-BS	---	---
	TRX350	1989-86	ETX14{75}	YTX14-BS	---	---
	TRX350 Rancher	2006-00	ETX14{75}	YTX14-BS	---	---
300cc	TRX300EX, Sportrax	2008-93	ETX9	YTX9-BS	---	---
	TRX300FW	2000-88	ETX14{75}	YTX14-BS	---	---
250cc	ATC250ES,SX	1987-81	ETX12	YTX12-BS	---	---
	TRX250 FourTrax	1987-85	ETX12	YTX12-BS	---	---

CC	MODEL	YEAR	PREMIUM AGM Activated/ Ready to-install	STANDARD DRY		
				STANDARD AGM	LOW MAINTENANCE- HIGH PERFORMANCE	CONVENTIONAL
HONDA (Continued)						
250cc	TRX250 FourTrax, Recon	2007-97	ETX12	YTX12-BS	---	---
	TRX250EX, Sportrax	2008-01	ETX9	YTX9-BS	---	---
200cc	ATC200	1986-81	ETX15{122}	YTX14AH-BS{72}	YB14A-A2	---
	ATC200X	1987	ETX12	YTX12-BS	---	---
	TRX200 FourTrax	1984	ETX15{122}	YTX14AH-BS{72}	YB14A-A2	---
	TRX200, SX FourTrax	1998-86	ETX12	YTX12-BS	---	---
125cc	ATC125M	1987-86	ETX12	YTX12-BS	---	---
	ATC125M	1985-84	---	---	YB9A-A	---
	TRX125	1988-87	ETX9	YTX9-BS	---	---
	TRX125	1986-85	---	---	YB9A-A	---
90cc	TRX90	2007-06	---	YTX5L-BS	---	---
HUSABERG						
All	All Models - Electric Start	2001	ETX9	YTX9-BS	---	---
KAWASAKI						
750cc	KVF750-A,B Brute Force 4x4	2005	---	KMX14-BS{68}	---	---
700cc	KSV700 (KFX700)	2008-04	---	KMX14-BS{68}	---	---
	KVF700A,B,D Prairie 4x4	2006-04	---	KMX14-BS{68}	---	---
650cc	KVF650 Prairie 650	2008-02	---	KMX14-BS{68}	---	---
400cc	KLF400 Bayou 4x4	2000-93	ETX16L{120}	YTX20HL-BS-PW{71}	YB16CL-B	---
	KSF400-A(KFX400)	2006-03	ETX9	YTX9-BS	---	---
	KVF400A,B Prairie 400 - Canada	2001-97	ETX16L{120}	YTX20HL-BS-PW{71}	YB16CL-B	---
	KVF400C,D Prairie 4x4 - Canada	2001-99	ETX14{75}	YTX14-BS	---	---
	KVF400C,D Prairie 4x4 - US	2002-97	ETX15{122}	YTX14AH-BS{72}	YB14A-A2	---
360cc	KVF360-A,B,C Prairie 4x4 - US	2008-03	ETX15{122}	YTX14AH-BS{72}	YB14A-A2	---
300cc	KEF300 Lakota	2003-95	ETX15{122}	YTX14AH-BS{72}	YB14A-A2	---
	KLF300 B,C Bayou 4x4 - US	2003-88	ETX15{122}	YTX14AH-BS{72}	YB14A-A2	---
	KLF300 Bayou	1987-85	ETX16L{120}	YTX20HL-BS-PW{71}	YB16CL-B	---
	KLF300C Bayou 4x4 - Canada	2005-92	ETX16L{120}	YTX20HL-BS-PW{71}	YB16CL-B	---
	KVF300A,B Prairie 4x4 - US	2002-99	ETX15{122}	YTX14AH-BS{72}	YB14A-A2	---
	KVF300B Prairie 300 - Canada	2002-99	ETX16L{120}	YTX20HL-BS-PW{71}	YB16CL-B	---
250cc	KL200 Duckster	1983	---	---	YB12A-A	12N12A-4A-1
	KLF250A-Bayou - Canada	2005-03	ETX15{122}	YTX14AH-BS{72}	YB14A-A2	---
	KLF250A-Bayou - US	2008-03	---	---	YB10A-A2	---
	KLT-250	1984-82	---	---	YB12A-A	12N12A-4A-1
	KLT-250 Prairie	1985-84	---	---	YB10L-B	12N10-3B
220cc	KLF220 Bayou - US	2002-88	---	---	YB10A-A2	---
	KLF220A Bayou - Canada	2002-92	ETX15{122}	YTX14AH-BS{72}	YB14A-A2	---
200cc	KLT-200	1983	---	---	YB12A-A	12N12A-4A-1
	KLT-200A	1984-81	---	---	YB10L-B	12N10-3B
185cc	KLF185 Bayou	1988-85	---	---	YB10L-B	12N10-3B
110cc	KLF110 Mojave	1988-87	---	---	YB9L-B	12N9-3B
90cc	KFX90	2008-07	---	YTX5L-BS	---	---
80cc	KSF80-A(KFX80)	2005-03	---	YTX5L-BS	---	---
PANDA						
125cc	KD125		---	---	YB7-A	12N7-4A
80cc	KD80		---	---	YB7-A	12N7-4A
50cc	KD50		---	---	YB7-A	12N7-4A
POLARIS						
800cc	Sportsman	2008-05	ETX30L{77}	YIX30L{61}	YB30L-B	---
700cc	Sportsman, Military	2008-02	ETX30L{77}	YIX30L{61}	YB30L-B	---
500cc	All Models ex. Predator	2008-99	ETX15{122}	YTX14AH-BS{72}	YB14A-A2	---
	Predator, Outlaw	2006-03	ETX9	YTX9-BS	---	---
	Ranger 6x6	2000-98	ETX30L{77}	YIX30L{61}	YB30L-B	---

{68} Available at Kawasaki dealers only. {71} Height with 20mm spacer included for use in replacing YB16CL-B.

{72} Includes 10mm spacer for additional height required in replacing YB14A-A1 and YB14A-A2.

{75} Shipped with 17mm adapter. {76} Shipped with 10mm adapter. {77} Does not meet Harley-Davidson OEM specifications.

{117} Battery must be rotated for correct polarity. Hold-down modifications may be necessary. Top and front terminal mounts only.

{119} Shipped with 17mm adapter. Top and front terminal mounts only. Hold-down modifications may be necessary.

{120} Shipped with 20mm adapter. Hold-down modifications may be necessary.

{122} Shipped with 10mm adapter. Hold-down modifications may be necessary. {124} Shipped with 17mm adapter that may be required for proper fit.

CC	MODEL	YEAR	PREMIUM AGM Activated/ Ready to-install	STANDARD DRY		
				STANDARD AGM	LOW MAINTENANCE-HIGH PERFORMANCE	CONVENTIONAL
POLARIS (Continued)						
450cc	Diesel .445 Liter - Diesel, Primary	2003-99	ETX30L{77}	YIX30L{61}	YB30L-B	---
	Diesel .445 Liter - Diesel, Secondary	2003-99	ETX15{122}	YTX14AH-BS{72}	YB14A-A2	---
425cc	All Models	2002-95	ETX15{122}	YTX14AH-BS{72}	YB14A-A2	---
400cc	All Models	2008-94	ETX15{122}	YTX14AH-BS{72}	YB14A-A2	---
335cc	Sportsman	2001-98	ETX15{122}	YTX14AH-BS{72}	YB14A-A2	---
330cc	Magnum, Trail Boss	2008-03	ETX15{122}	YTX14AH-BS{72}	YB14A-A2	---
325cc	All Models	2002-87	ETX15{122}	YTX14AH-BS{72}	YB14A-A2	---
300cc	Hawkeye 4x4	2007	ETX15{76}	YTX14AH-BS	YB14-B2	---
250cc	All Models	2005-85	ETX15{122}	YTX14AH-BS{72}	YB14A-A2	---
200cc	Phoenix, Sawtooth	2008-05	ETX12	YTX12-BS	---	---
90cc	Predator, Sportsman, Outlaw	2008-03	---	YTX5L-BS	---	---
	Scrambler, Sportsman	2002-01	---	YTX4L-BS	---	---
50cc	Predator, Outlaw	2008-04	---	YTX5L-BS	---	---
	Scrambler	2003	---	YTX5L-BS	---	---
	Scrambler	2002-01	---	YTX4L-BS	---	---
SUZUKI						
700cc	LT-700 King Quad	2007-05	---	YTX20CH-BS	---	---
	LT-V700F Twin Peaks	2005-04	---	KMX14-BS{68}	---	---
500cc	LT-A500F Vinson - 4WD	2007-04	---	YTX20CH-BS	---	---
	LT-A500F Vinson - 4WD	2003-02	ETX14{124}	YTX20CH-BS	YTX16-BS	---
	LT-F500F Vinson - w/MT, 4WD	2007-04	---	YTX20CH-BS	---	---
	LT-F500F Vinson - w/MT, 4WD	2003	ETX14{124}	YTX20CH-BS	YTX16-BS	---
	LT-F500F-QuadRunner	2002-98	ETX14{119}	YTX16-BS-1	---	---
450cc	LT-A450X King Quad - 4WD	2008-07	ETX14{75}	YTX14-BS	---	---
	LT-R450 QuadRacer - 4WD	2008-06	---	YTZ10S	YTX7A-BS	---
400cc	LT-A400,F	2007-02	ETX14{75}	YTX14-BS	---	---
	LT-Z400 QuadSport	2008-03	ETX9	YTX9-BS	---	---
300cc	LT-300E Quadrunner	1989-87	ETX15{122}	YTX14AH-BS{72}	YB14A-A2	---
	LT-F300F KingQuad	2002-99	ETX15{122}	YTX14AH-BS{72}	YB14A-A2	---
	LT-F300F KingQuad - Canada or Optional US	2002-99	ETX18L{117}	---	---	---
280cc	LT-F4WDX King Quad	1998-91	ETX15{122}	YTX14AH-BS{72}	YB14A-A2	---
	LT-F4WDX King Quad - Canada or Optional US	1999-91	ETX18L{117}	---	---	---
250cc	LT-250,F,Quadrunner - Canada or Optional US	2002-87	ETX18L{117}	---	---	---
	LT-250EF Quadrunner	1986-85	ETX18L{117}	---	---	---
	LT-4WD Quadrunner	1999-87	ETX15{122}	YTX14AH-BS{72}	YB14A-A2	---
	LT-F250 Quadrunner	2002-88	ETX15{122}	YTX14AH-BS{72}	YB14A-A2	---
	LT-F250,F Ozark	2008-02	ETX12	YTX12-BS	---	---
	LT-Z250 QuadSport	2008-04	ETX9	YTX9-BS	---	---
230cc	LT-230E Quadrunner	1993-88	ETX12	YTX12-BS	---	---
	LT-230E Quadrunner	1987	NA	---	---	---
	LT-230GE Quadrunner	1986-85	---	---	YB10A-A2	---
	LT-F230 Quadrunner	1987-86	---	---	YB10A-A2	---
160cc	LT-160E,F Quadrunner	2004-89	---	---	YB9A-A	---
90cc	LTZ90	2008-07	---	YTX7A-BS	---	---
80cc	LT-80 QuadSport	2006-87	---	YTZ7S	YTX5L-BS	---
50cc	QuadSport Z50	2008-06	---	YTZ7S	YTX5L-BS	---
YAMAHA						
700cc	YFM700FG Grizzly	2008-07	ETX20L	YTX20L-BS	---	---
	YFM700R Raptor	2008-06	---	YT9B-4{61}	---	---
660cc	YFM600 Grizzly	2008-02	ETX20L	YTX20L-BS	---	---
	YFM660R Raptor	2005-01	ETX14{75}	YTX14-BS	---	---
600cc	YFM600 Grizzly	2001-98	ETX20L	YTX20L-BS	---	---
450cc	YFM Kodiak	2006-04	ETX20L	YTX20L-BS	---	---
	YFM450,FG Grizzly	2008-07	ETX15{76}	YTX14AH-BS	---	---
	YFM450FX Wolverine	2008-06	ETX20L	YTX20L-BS	---	---
	YFZ450	2008-04	---	YT7B-BS	---	---
400cc	YFM400 Big Bear - 2WD	2003-00	ETX20L	YTX20L-BS	---	---
	YFM400 Big Bear - 4WD	2008-00	ETX20L	YTX20L-BS	---	---

CC	MODEL	YEAR	PREMIUM AGM Activated/ Ready to-install	STANDARD DRY		
				STANDARD AGM	LOW MAINTENANCE- HIGH PERFORMANCE	CONVENTIONAL
YAMAHA (Continued)						
400cc	YFM400F(A) Kodiak - w/AT	2003	ETX15{76}	YTX14AH-BS	---	---
	YFM400F(A) Kodiak - w/AT	2002-96	ETX20L	YTX20L-BS	---	---
	YFM400FW Kodiak 4x4	1995-93	ETX15{122}	YTX14AH-BS{72}	YB14A-A1	---
350cc	BW350 Big Wheel	1988-87	ETX12{56}	YTX12-BS{56}	YB12B-B2	---
	Bruin	2008-06	ETX15{76}	YTX14AH-BS	---	---
	Bruin	2005	---	---	YB12C-A	---
	Raptor	2008-06	---	YTX10S{61}	---	---
	Raptor	2005	---	---	YB12C-A	---
	YFM350ER	1995-87	ETX15{122}	YTX14AH-BS{72}	YB14A-A1	---
	YFM350FW Big Bear 4x4	1999-87	ETX15{122}	YTX14AH-BS{72}	YB14A-A1	---
	YFM350FX Wolverine	2008-06	ETX15{76}	YTX14AH-BS	---	---
	YFM350FX Wolverine 4x4	2005-95	---	---	YB12C-A	---
	YFM350G,FG Grizzly	2008-07	ETX15{76}	YTX14AH-BS	---	---
	YFM350U Big Bear 4x2	1999-96	ETX15{122}	YTX14AH-BS{72}	YB14A-A1	---
	YFM350X Warrior	2003-87	---	---	YB12C-A	---
	YFP350 Terra-Pro	1988	ETX15{122}	YTX14AH-BS{72}	YB14A-A1	---
	YFU1 Pro-Hauler	1989	ETX15{122}	YTX14AH-BS{72}	YB14A-A1	---
250cc	YFB250 Timberwolf	2000-92	---	---	YB12C-A	---
	YFM250	1991-89	ETX15{122}	YTX14AH-BS{72}	YB14A-A1	---
	YFM250 Bear Tracker	2004-99	ETX15{122}	YTX14AH-BS{72}	YB14A-A2	---
	YFM250B Big Bear	2008-07	ETX15{122}	YTX14AH-BS{72}	YB14A-A2	---
	YFM250B Bruin	2006-05	ETX15{122}	YTX14AH-BS{72}	YB14A-A2	---
	YFM250R Raptor	2008	---	YTX7S{61}	---	---
230cc	YFM25X Bear Tracker	2002-99	ETX15{122}	YTX14AH-BS{72}	YB14A-A1	---
225cc	YFM225	1988-86	ETX15{122}	YTX14AH-BS{72}	YB14A-A1	---
	YTM225DR,DX	1986-83	ETX15{122}	YTX14AH-BS{72}	YB14A-A1	---
200cc	BW200 Big Wheel	1988-85	---	---	YB7C-A	---
	YFM200,DX	1989-85	ETX15{122}	YTX14AH-BS{72}	YB14A-A1	---
	YTM200	1985-83	ETX15{122}	YTX14AH-BS{72}	YB14A-A1	---
125cc	YFA1 Breeze	2003-89	---	---	YB12C-A	---
100cc	YFA1 Breeze	1989	---	---	YB12C-A	---
	YFM100 Champ	1991-87	---	---	---	12N7D-3B
80cc	YFM80 Badger	2002-85	---	---	---	12N7D-3B
	YFM80 Grizzly	2008-05	---	---	---	12N7D-3B
	YFM80W Raptor	2008-02	---	---	---	12N7D-3B
50cc	Raptor 50	2008-04	---	---	---	12N7D-3B

{56} Hold-down modifications may be necessary. {61} Activated ready to install.

{66} The YTX20 series batteries may be used as an optional upgrade. See battery label for retrofit cautions.

{71} Height with 20mm spacer included for use in replacing YB16CL-B.

{72} Includes 10mm spacer for additional height required in replacing YB14A-A1 and YB14A-A2.

{76} Shipped with 10mm adapter. {77} Does not meet Harley-Davidson OEM specifications.

{118} Shipped with 20mm adapter. Top and front terminal mounts only.

{120} Shipped with 20mm adapter. Hold-down modifications may be necessary.

{122} Shipped with 10mm adapter. Hold-down modifications may be necessary.

APPLICATION DATA

PERSONAL WATERCRAFT

CC	MODEL	YEAR	PREMIUM AGM Activated/ Ready to-install	STANDARD DRY		
				STANDARD AGM	LOW MAINTENANCE- HIGH PERFORMANCE	CONVENTIONAL
AQUA-JET						
ALL	SX1 (All)	1991-89	ETX16{120}	YTX20-BS{66}	YB16-B-LM	YB16-B
ARCTIC CAT-TIGERSHARK						
ALL	Tigershark(All Models)	2004-93	ETX16{120}	---	YB16C-B	---
BOMBARDIER-SEA-DOO						
1500cc	All Other Models	2005	ETX16L{120}	YTX20HL-BS-PW{71}	YB16CL-B	---
	GTX 4-TEC,RXP	2007-02	ETX30LA	---	YB30CL-B	---
950cc	All Other Models	2004-97	ETX16L{120}	YTX20HL-BS-PW{71}	YB16CL-B	---
	GTX 4-TEC,RXP	2004-99	ETX30LA	---	YB30CL-B	---
780cc	All Other Models	2007-03	ETX16L{120}	YTX20HL-BS-PW{71}	YB16CL-B	---
	All Other Models	2000-95	ETX16L{120}	YTX20HL-BS-PW{71}	YB16CL-B	---
	GTX 4-TEC,RXP	2002-96	ETX30LA	---	YB30CL-B	---
720cc	All Other Models	2005-95	ETX16L{120}	YTX20HL-BS-PW{71}	YB16CL-B	---
650cc	All Models	1993	ETX16L{120}	YTX20L-BS	YB16L-B	12N16-3B
	All Other Models	1995-94	ETX16L{120}	YTX20HL-BS-PW{71}	YB16CL-B	---
	GTX 4-TEC,RXP	1995-94	ETX30LA	---	YB30CL-B	---
580cc	All Models	1993-88	ETX16L{120}	YTX20L-BS	YB16L-B	12N16-3B
	All Other Models	1997-94	ETX16L{120}	YTX20HL-BS-PW{71}	YB16CL-B	---
	GTX 4-TEC,RXP	1993-92	ETX30LA	---	YB30CL-B	---
HONDA						
1200cc	AquaTrax F-12,12X	2007-02	ETX20L	YTX20L-BS	---	---
	AquaTrax R-12,12X	2007-02	ETX20L	YTX20L-BS	---	---
KAWASAKI						
1500cc	JT1500, STX-15F	2008-04	ETX20L	YTX20L-BS	---	---
1200cc	JH1200-A, B Ultra 150	2005-99	ETX20L	YTX20L-BS	---	---
	JT1200-A STX-R	2007-02	ETX20L	YTX20L-BS	---	---
1100cc	JH1100 ZXi	2003-96	ETX20L	YTX20L-BS	---	---
	JH1100-B Ultra 130	2004-01	ETX20L	YTX20L-BS	---	---
	JT1100 STX	2003-97	ETX20L	YTX20L-BS	---	---
900cc	JT900	2005-95	ETX20L	YTX20L-BS	---	---
800cc	JS800 SX-R	2008-03	ETX20L	YTX20L-BS	---	---
750cc	JH750,SS,ST, Xi	1999-92	ETX16L{120}	YTX20HL-BS-PW{71}	YB16CL-B	---
	JH750ST	1996	ETX30L{77}	YIX30L{61}	YB30L-B	---
	JS750 ST, Sxi	2002-95	ETX20L	YTX20L-BS	---	---
650cc	JF,JL,JS 650	1996-86	ETX16L{120}	YTX20HL-BS-PW{71}	YB16CL-B	---
550cc	JS550	1995-86	ETX16L{120}	YTX20HL-BS-PW{71}	YB16CL-B	---
	JS550	1985-82	ETX16L{120}	YTX20L-BS	YB16L-B	12N16-3B
440cc	JS440	1992-87	ETX16L{120}	YTX20HL-BS-PW{71}	YB16CL-B	---
	JS440	1986-77	ETX16L{120}	YTX20L-BS	YB16L-B	12N16-3B
400cc	JS400	1976	ETX16L{120}	YTX20L-BS	YB16L-B	12N16-3B
300cc	JS300	1991-86	ETX16L{120}	YTX20HL-BS-PW{71}	YB16CL-B	---
POLARIS						
1200cc	All Models	2004-99	ETX16L{120}	YTX20HL-BS-PW{71}	YB16CL-B	---
1050cc	All Models	1999-96	ETX16L{120}	YTX20HL-BS-PW{71}	YB16CL-B	---
900cc	All Models	1997-96	ETX16L{120}	YTX20HL-BS-PW{71}	YB16CL-B	---
800cc	All Models	2004-02	ETX16L{120}	YTX20HL-BS-PW{71}	YB16CL-B	---
785cc	All Models	2000-98	ETX16L{120}	YTX20HL-BS-PW{71}	YB16CL-B	---
780cc	All Models	1997-96	ETX16L{120}	YTX20HL-BS-PW{71}	YB16CL-B	---
750cc	All Models	2004-03	ETX16L{120}	YTX20HL-BS-PW{71}	YB16CL-B	---
	All Models	1995-94	ETX16L{120}	YTX20HL-BS-PW{71}	YB16CL-B	---
700cc	All Models	2004-96	ETX16L{120}	YTX20HL-BS-PW{71}	YB16CL-B	---
650cc	All Models	1995-94	ETX16L{120}	YTX20HL-BS-PW{71}	YB16CL-B	---
UTRANAUTICS						
800cc	Seaflash,Wetbike	1991-87	ETX16L{118}	---	53030	---
	Wetbike	1986	---	---	---	YHD-12

PERSONAL WATERCRAFT

APPLICATION DATA

CC	MODEL	YEAR	PREMIUM AGM Activated/ Ready to-install	STANDARD DRY		
				STANDARD AGM	LOW MAINTENANCE- HIGH PERFORMANCE	CONVENTIONAL
YAMAHA						
1200cc	All WaveRunner Models	2005-99	ETX16L{120}	YTX20HL-BS-PW{71}	YB16CL-B	---
1100cc	All WaveRunner Models	1998-91	ETX16L{120}	YTX20HL-BS-PW{71}	YB16CL-B	---
1000cc	All WaveRunner Models	1990-87	ETX16L{120}	YTX20HL-BS-PW{71}	YB16CL-B	---
800cc	All WaveRunner Models	2007-98	ETX16L{120}	YTX20HL-BS-PW{71}	YB16CL-B	---
760cc	All WaveRunner Models	2000-96	ETX16L{120}	YTX20HL-BS-PW{71}	YB16CL-B	---
700cc	All WaveRunner Models	2004-93	ETX16L{120}	YTX20HL-BS-PW{71}	YB16CL-B	---
	FX700 FX1	1996-94	ETX16L{120}	YTX20HL-BS-PW{71}	YB16CL-B	---
	SJ700 SuperJet	2005-94	ETX16L{120}	YTX20HL-BS-PW{71}	YB16CL-B	---
650cc	All WaveRunner Models	1996-90	ETX16L{120}	YTX20HL-BS-PW{71}	YB16CL-B	---
	SJ650 SuperJet	1993-90	ETX16L{120}	YTX20HL-BS-PW{71}	YB16CL-B	---
500cc	All WaveRunner Models	1993-87	ETX16L{120}	YTX20HL-BS-PW{71}	YB16CL-B	---

{64} Top and front terminal mounts only. {71} Height with 20mm spacer included for use in replacing YB16CL-B.

{76} Shipped with 10mm adapter. {104} Hold-down modifications may be necessary. Requires activation.

{120} Shipped with 20mm adapter. Hold-down modifications may be necessary.

APPLICATION DATA

SNOWMOBILES

CC	MODEL	YEAR	PREMIUM AGM Activated/ Ready to-install	STANDARD DRY		
				STANDARD AGM	LOW MAINTENANCE- HIGH PERFORMANCE	CONVENTIONAL
ARCTIC CAT						
	250 Z	1977	ETX15L	YTX14AHL-BS	YB14L-A2	12N14-3A
	340 Z	1977	ETX15L	YTX14AHL-BS	YB14L-A2	12N14-3A
	440 Z	1977	ETX15L	YTX14AHL-BS	YB14L-A2	12N14-3A
	All	1976-71	ETX15L	YTX14AHL-BS	YB14L-A2	12N14-3A
	Bearcat 340,440	2000-95	ETX15{76}	YTX14AH-BS	YB14-A2	---
	Bearcat 550 WT	1999-95	---	YTX20-BS{104}	YB18-A	---
	Bearcat 570	2007-04	ETX18L{64}	YTX24HL-BS{64}	Y50-N18L-A-LM	Y50-N18L-A
	Bearcat WT	2007-03	ETX18L{64}	YTX24HL-BS{64}	Y50-N18L-A-LM	Y50-N18L-A
	Bearcat WT	2002-00	---	YTX20-BS{104}	YB18-A	---
	Bearcat WT Turbo	2007-06	ETX18L{64}	YTX24HL-BS{64}	Y50-N18L-A-LM	Y50-N18L-A
	Cheetah	1994	ETX15{76}	YTX14AH-BS	YB14-A2	---
	Cheetah	1993-91	ETX15L	YTX14AHL-BS	YB14L-A2	12N14-3A
	Cheetah	1990-86	ETX16L{120}	YTX20L-BS	YB16L-B	12N16-3B
	Cheetah	1978-72	ETX15L	YTX14AHL-BS	YB14L-A2	12N14-3A
	Cheetah 340, 440	1994	ETX15{76}	YTX14AH-BS	YB14-A2	---
	Cougar	1998-95	---	YTX20-BS{104}	YB18-A	---
	Cougar	1994-91	ETX15L	YTX14AHL-BS	YB14L-A2	12N14-3A
	Cougar	1990-85	ETX16L{120}	YTX20L-BS	YB16L-B	12N16-3B
	Cross Country Cat	1977	ETX15L	YTX14AHL-BS	YB14L-A2	12N14-3A
	Crossfire 5, 6, 7	2007-06	---	YTX20-BS{104}	YB18-A	---
	EXT	1994-93	ETX15L	YTX14AHL-BS	YB14L-A2	12N14-3A
	EXT (Carb)	1996-95	---	---	YB7-A	12N7-4A
	EXT 600 Triple	1998-97	---	YTX20-BS{104}	YB18-A	---
	EXT Dix EFI	1998-97	ETX18L{64}	YTX24HL-BS{64}	Y50-N18L-A-LM	Y50-N18L-A
	EXT EFI	1998	---	YTX20-BS{104}	YB18-A	---
	EXT EFI	1997-95	---	---	YB7-A	12N7-4A
	El Tigre	1992-84	ETX15L	YTX14AHL-BS	YB14L-A2	12N14-3A
	El Tigre	1981-73	ETX15L	YTX14AHL-BS	YB14L-A2	12N14-3A
	F 120	2006	ETX16L{120}	YTX20L-BS	YB16L-B	12N16-3B
	F6, F8,F1000	2007	---	YTX20-BS{104}	YB18-A	---
	Firecat	2006-03	ETX18L{64}	YTX24HL-BS{64}	Y50-N18L-A-LM	Y50-N18L-A
	Jag	1994	ETX15{76}	YTX14AH-BS	YB14-A2	---
	Jag	1993-85	ETX15L	YTX14AHL-BS	YB14L-A2	12N14-3A
	Jag	1981-80	ETX15L	YTX14AHL-BS	YB14L-A2	12N14-3A
	Jag 3000	1980-77	ETX15L	YTX14AHL-BS	YB14L-A2	12N14-3A
	Jag 340	1999-98	ETX15{76}	YTX14AH-BS	YB14-A2	---
	Jag 340	1991-87	ETX15L	YTX14AHL-BS	YB14L-A2	12N14-3A
	Jag Liquid	1996	ETX15{76}	YTX14AH-BS	YB14-A2	---
	Jag, Deluxe	1999-94	ETX15{76}	YTX14AH-BS	YB14-A2	---
	Jaguar	2007	---	YTX20-BS{104}	YB18-A	---
	King Cat	2006-04	ETX18L{64}	YTX24HL-BS{64}	Y50-N18L-A-LM	Y50-N18L-A
	Kitty Cat	2000-94	ETX15{76}	YTX14AH-BS	YB14-A2	---
	Kitty Cat	1993-72	ETX15L	YTX14AHL-BS	YB14L-A2	12N14-3A
	Lynx	1993-91	ETX15L	YTX14AHL-BS	YB14L-A2	12N14-3A
	Lynx	1980-71	ETX15L	YTX14AHL-BS	YB14L-A2	12N14-3A
	M5, M6, M7	2007-05	---	YTX20-BS{104}	YB18-A	---
	Mountain Cat	2002-01	---	YTX20-BS{104}	YB18-A	---
	Mountain Cat 1000	2002-01	---	YTX20-BS{104}	YB18-A	---
	Mountain Cat 570	2004-03	ETX18L{64}	YTX24HL-BS{64}	Y50-N18L-A-LM	Y50-N18L-A
	Mountain Cat 600	2004-01	---	YTX20-BS{104}	YB18-A	---
	Mountain Cat 800	2004-01	ETX18L{64}	YTX24HL-BS{64}	Y50-N18L-A-LM	Y50-N18L-A
	Mountain Cat 900	2004-02	ETX18L{64}	YTX24HL-BS{64}	Y50-N18L-A-LM	Y50-N18L-A
	Pantera	2001-99	---	YTX20-BS{104}	YB18-A	---
	Pantera	1998-95	ETX18L{64}	YTX24HL-BS{64}	Y50-N18L-A-LM	Y50-N18L-A
	Pantera	1994	---	YTX20-BS{104}	YB18-A	---
	Pantera	1993-86	ETX15L	YTX14AHL-BS	YB14L-A2	12N14-3A
	Pantera	1985-79	ETX16L{120}	YTX20L-BS	YB16L-B	12N16-3B
	Pantera	1978	ETX16L{120}	YTX20L-BS	YB16L-B	12N16-3B
	Pantera	1978	ETX15L	YTX14AHL-BS	YB14L-A2	12N14-3A

SNOWMOBILES

CC	MODEL	YEAR	PREMIUM AGM Activated/ Ready to-install	STANDARD DRY		
				STANDARD AGM	LOW MAINTENANCE- HIGH PERFORMANCE	CONVENTIONAL
ARCTIC CAT (Continued)						
	Pantera	1977	ETX16L{120}	YTX20L-BS	YB16L-B	12N16-3B
	Pantera	1977	ETX15L	YTX14AHL-BS	YB14L-A2	12N14-3A
	Pantera 550, 600	2005-02	---	YTX20-BS{104}	YB18-A	---
	Pantera 580	2001-99	---	YTX20-BS{104}	YB18-A	---
	Pantera 800	2004-02	ETX18L{64}	YTX24HL-BS{64}	Y50-N18L-A-LM	Y50-N18L-A
	Panther	1996-94	ETX15{76}	YTX14AH-BS	YB14-A2	---
	Panther	1993-89	ETX15L	YTX14AHL-BS	YB14L-A2	12N14-3A
	Panther	1988-84	ETX16L{120}	YTX20L-BS	YB16L-B	12N16-3B
	Panther	1981-79	ETX16L{120}	YTX20L-BS	YB16L-B	12N16-3B
	Panther	1978-71	ETX15L	YTX14AHL-BS	YB14L-A2	12N14-3A
	Panther 340	2000-98	ETX15{76}	YTX14AH-BS	YB14-A2	---
	Panther 370	2007-04	ETX15{76}	YTX14AH-BS	YB14-A2	---
	Panther 370	2001	ETX15{76}	YTX14AH-BS	YB14-A2	---
	Panther 440	2003-97	ETX15{76}	YTX14AH-BS	YB14-A2	---
	Panther 550	2001-97	---	YTX20-BS{104}	YB18-A	---
	Panther 570, 660	2007-02	ETX18L{64}	YTX24HL-BS{64}	Y50-N18L-A-LM	Y50-N18L-A
	Powder Extreme, Special	2000-97	---	YTX20-BS{104}	YB18-A	---
	Prowler	1994	---	---	YB7-A	12N7-4A
	Prowler	1993-90	ETX15L	YTX14AHL-BS	YB14L-A2	12N14-3A
	Prowler 2-Up	1995	---	YTX20-BS{104}	YB18-A	---
	Prowler Special	1992-91	---	YTX20-BS{104}	YB18-A	---
	Puma	1997-94	ETX15{76}	YTX14AH-BS	YB14-A2	---
	Puma	1973-71	ETX15L	YTX14AHL-BS	YB14L-A2	12N14-3A
	Sabercat 500	2006-04	---	YTX20-BS{104}	YB18-A	---
	Sabercat 600, 700	2006-04	ETX18L{64}	YTX24HL-BS{64}	Y50-N18L-A-LM	Y50-N18L-A
	Super Jag	1992-89	ETX15L	YTX14AHL-BS	YB14L-A2	12N14-3A
	T600 Turbo, Touring	2007-02	ETX18L{64}	YTX24HL-BS{64}	Y50-N18L-A-LM	Y50-N18L-A
	Thundercat	2002-93	---	YTX20-BS{104}	YB18-A	---
	Trail 4-Stroke	2003-02	ETX18L{64}	YTX24HL-BS{64}	Y50-N18L-A-LM	Y50-N18L-A
	Trail Cat 3000	1980-79	ETX15L	YTX14AHL-BS	YB14L-A2	12N14-3A
	Trail Cat 4000	1981	ETX15L	YTX14AHL-BS	YB14L-A2	12N14-3A
	Triple Touring 600	2001-99	ETX18L{64}	YTX24HL-BS{64}	Y50-N18L-A-LM	Y50-N18L-A
	VIP	1976-74	ETX15L	YTX14AHL-BS	YB14L-A2	12N14-3A
	Wildcat	1992-87	ETX18L{64}	YTX24HL-BS{64}	Y50-N18L-A-LM	Y50-N18L-A
	Wildcat 700	1992-91	---	---	YB7-A	12N7-4A
	Wildcat EFI	1993	ETX16L{120}	YTX20L-BS	YB16L-B	12N16-3B
	Wildcat MC, EFI	1996-94	---	---	YB7-A	12N7-4A
	Wildcat Touring	1996-95	---	---	YB7-A	12N7-4A
	Z	2001-95	ETX15{76}	YTX14AH-BS	YB14-A2	---
	Z 570	2007-02	ETX18L{64}	YTX24HL-BS{64}	Y50-N18L-A-LM	Y50-N18L-A
	Z, 370, 440	2007-02	ETX15{76}	YTX14AH-BS	YB14-A2	---
	ZL	2001-00	---	YTX20-BS{104}	YB18-A	---
	ZL 440,500	2002	---	YTX20-BS{104}	YB18-A	---
	ZL 440,500	2000-97	ETX15{76}	YTX14AH-BS	YB14-A2	---
	ZL 550, 600	2003-02	---	YTX20-BS{104}	YB18-A	---
	ZL 800	2003-02	ETX18L{64}	YTX24HL-BS{64}	Y50-N18L-A-LM	Y50-N18L-A
	ZR	2001-99	---	YTX20-BS{104}	YB18-A	---
	ZR 120	2005-02	ETX15{76}	YTX14AH-BS	YB14-A2	---
	ZR 440	2001	ETX15{76}	YTX14AH-BS	YB14-A2	---
	ZR 440	1998-97	ETX15{76}	YTX14AH-BS	YB14-A2	---
	ZR 440	1993	ETX15L	YTX14AHL-BS	YB14L-A2	12N14-3A
	ZR 500, 600	2003-00	---	YTX20-BS{104}	YB18-A	---
	ZR 580	1994	---	YTX20-BS{104}	YB18-A	---
	ZR 700	1994	---	YTX20-BS{104}	YB18-A	---
	ZR 800, EFI	2003-02	ETX18L{64}	YTX24HL-BS{64}	Y50-N18L-A-LM	Y50-N18L-A
	ZR 900	2006-03	ETX18L{64}	YTX24HL-BS{64}	Y50-N18L-A-LM	Y50-N18L-A
	ZR EFI	2002	ETX15{76}	YTX14AH-BS	YB14-A2	---

{64} Top and front terminal mounts only. {76} Shipped with 10mm adapter.
 {104} Hold-down modifications may be necessary. Requires activation.
 {120} Shipped with 20mm adapter. Hold-down modifications may be necessary.

SNOWMOBILES

CC	MODEL	YEAR	PREMIUM AGM Activated/ Ready to-install	STANDARD DRY		
				STANDARD AGM	LOW MAINTENANCE-HIGH PERFORMANCE	CONVENTIONAL
ARCTIC CAT (Continued)						
	ZR EFI	1997-95	---	---	YB7-A	12N7-4A
	ZR EFI	1994	ETX15{76}	YTX14AH-BS	YB14-A2	---
	ZRT	2002-95	---	YTX20-BS{104}	YB18-A	---
BOMBARDIER-SKI-DOO						
1500cc	Elite 1500	2006-04	ETX30L	YIX30L	---	---
1000cc	All Models,CK3,4-Stroke Types	2006-03	ETX18L{64}	YTX24HL-BS{64}	Y50-N18L-A-LM	Y50-N18L-A
	Summit	2006-05	---	YTX4L-BS	---	---
800cc	Formula III 800	2000-99	ETX18L{64}	YTX24HL-BS{64}	Y50-N18L-A-LM	Y50-N18L-A
	GSX, GTX	2006-04	ETX18L{64}	YTX24HL-BS{64}	Y50-N18L-A-LM	Y50-N18L-A
	Grand Touring, Legend	2004-99	ETX18L{64}	YTX24HL-BS{64}	Y50-N18L-A-LM	Y50-N18L-A
	Mach Z	1998-94	ETX18L{64}	YTX24HL-BS{64}	Y50-N18L-A-LM	Y50-N18L-A
	Summit X	2006-01	ETX18L{64}	YTX24HL-BS{64}	Y50-N18L-A-LM	Y50-N18L-A
	TNT 775	1972-70	ETX18L{64}	YTX24HL-BS{64}	Y50-N18L-A-LM	Y50-N18L-A
700cc	Formula	2001-96	ETX18L{64}	YTX24HL-BS{64}	Y50-N18L-A-LM	Y50-N18L-A
	Grand Touring, Legend	2004-94	ETX18L{64}	YTX24HL-BS{64}	Y50-N18L-A-LM	Y50-N18L-A
	Mach I	2000-94	ETX18L{64}	YTX24HL-BS{64}	Y50-N18L-A-LM	Y50-N18L-A
	Summit 700	2003-99	ETX18L{64}	YTX24HL-BS{64}	Y50-N18L-A-LM	Y50-N18L-A
670cc	Formula Z	1999-93	ETX18L{64}	YTX24HL-BS{64}	Y50-N18L-A-LM	Y50-N18L-A
	Summit 670	1999-95	ETX18L{64}	YTX24HL-BS{64}	Y50-N18L-A-LM	Y50-N18L-A
635cc	Alpine	1995-75	ETX18L{64}	YTX24HL-BS{64}	Y50-N18L-A-LM	Y50-N18L-A
	TNT 640	1972-70	ETX18L{64}	YTX24HL-BS{64}	Y50-N18L-A-LM	Y50-N18L-A
600cc	Expedition TUV 600	2006-05	ETX18L{64}	YTX24HL-BS{64}	Y50-N18L-A-LM	Y50-N18L-A
	Formula 600	2001-97	ETX18L{64}	YTX24HL-BS{64}	Y50-N18L-A-LM	Y50-N18L-A
	GSX, GTX 600	2006-04	ETX18L{64}	YTX24HL-BS{64}	Y50-N18L-A-LM	Y50-N18L-A
	Grand Touring, Legend	2004-00	ETX18L{64}	YTX24HL-BS{64}	Y50-N18L-A-LM	Y50-N18L-A
	Skandic, Summit	2006-99	ETX18L{64}	YTX24HL-BS{64}	Y50-N18L-A-LM	Y50-N18L-A
583cc	Formula,GT,MX,Summit	1999-89	ETX18L{64}	YTX24HL-BS{64}	Y50-N18L-A-LM	Y50-N18L-A
550cc	Blizzard 9700	1984	ETX18L{64}	YTX24HL-BS{64}	Y50-N18L-A-LM	Y50-N18L-A
	Expedition Sport	2006-05	ETX18L{64}	YTX24HL-BS{64}	Y50-N18L-A-LM	Y50-N18L-A
	GSX, GTX 550	2006	ETX18L{64}	YTX24HL-BS{64}	Y50-N18L-A-LM	Y50-N18L-A
	Grand Touring 550	2003	ETX18L{64}	YTX24HL-BS{64}	Y50-N18L-A-LM	Y50-N18L-A
	Legend 550	2004-03	ETX18L{64}	YTX24HL-BS{64}	Y50-N18L-A-LM	Y50-N18L-A
	Safari Grand Luxe	1986-84	ETX18L{64}	YTX24HL-BS{64}	Y50-N18L-A-LM	Y50-N18L-A
	Skandic, Summit 550	2006-03	ETX18L{64}	YTX24HL-BS{64}	Y50-N18L-A-LM	Y50-N18L-A
500cc	Blizzard, Everest	1985-79	ETX18L{64}	YTX24HL-BS{64}	Y50-N18L-A-LM	Y50-N18L-A
	Escapade	1989-87	ETX18L{64}	YTX24HL-BS{64}	Y50-N18L-A-LM	Y50-N18L-A
	Formula 500	2001-85	ETX18L{64}	YTX24HL-BS{64}	Y50-N18L-A-LM	Y50-N18L-A
	GSX, GTX 500 Sport	2006-04	ETX18L{64}	YTX24HL-BS{64}	Y50-N18L-A-LM	Y50-N18L-A
	Grand Touring 500	2003-97	ETX18L{64}	YTX24HL-BS{64}	Y50-N18L-A-LM	Y50-N18L-A
	Legend 500	2004-02	ETX18L{64}	YTX24HL-BS{64}	Y50-N18L-A-LM	Y50-N18L-A
	Nordic 60	1991-87	ETX18L{64}	YTX24HL-BS{64}	Y50-N18L-A-LM	Y50-N18L-A
	Safari, Skandic	2003-87	ETX18L{64}	YTX24HL-BS{64}	Y50-N18L-A-LM	Y50-N18L-A
	Stratos	1988-87	ETX18L{64}	YTX24HL-BS{64}	Y50-N18L-A-LM	Y50-N18L-A
	Summit, Touring	2002-95	ETX18L{64}	YTX24HL-BS{64}	Y50-N18L-A-LM	Y50-N18L-A
470cc	Elite	1982-78	ETX18L{64}	YTX24HL-BS{64}	Y50-N18L-A-LM	Y50-N18L-A
	Elite	1975	ETX18L{64}	YTX24HL-BS{64}	Y50-N18L-A-LM	Y50-N18L-A
	Grand Touring 470	1995	ETX18L{64}	YTX24HL-BS{64}	Y50-N18L-A-LM	Y50-N18L-A
	MX XTC	1991	ETX18L{64}	YTX24HL-BS{64}	Y50-N18L-A-LM	Y50-N18L-A
	Safari GLX	1992-90	ETX18L{64}	YTX24HL-BS{64}	Y50-N18L-A-LM	Y50-N18L-A
	Summit 470	1994	ETX18L{64}	YTX24HL-BS{64}	Y50-N18L-A-LM	Y50-N18L-A
440cc	All Models	1980	ETX15L	YTX14AHL-BS	YB14L-A2	12N14-3A
	Blizzard, Everest	1983-77	ETX18L{64}	YTX24HL-BS{64}	Y50-N18L-A-LM	Y50-N18L-A
	Blizzard, Everest	1975	ETX18L{64}	YTX24HL-BS{64}	Y50-N18L-A-LM	Y50-N18L-A
	Nordic 50	1991-87	ETX18L{64}	YTX24HL-BS{64}	Y50-N18L-A-LM	Y50-N18L-A
	Safari	1992-90	ETX18L{64}	YTX24HL-BS{64}	Y50-N18L-A-LM	Y50-N18L-A
	Safari	1986-84	ETX18L{64}	YTX24HL-BS{64}	Y50-N18L-A-LM	Y50-N18L-A
	Skandic 440	2006-01	ETX18L{64}	YTX24HL-BS{64}	Y50-N18L-A-LM	Y50-N18L-A
	TNT 440	1978-71	ETX18L{64}	YTX24HL-BS{64}	Y50-N18L-A-LM	Y50-N18L-A
	Touring LE	2000-95	ETX18L{64}	YTX24HL-BS{64}	Y50-N18L-A-LM	Y50-N18L-A

SNOWMOBILES

CC	MODEL	YEAR	PREMIUM AGM Activated/ Ready to-install	STANDARD DRY		
				STANDARD AGM	LOW MAINTENANCE- HIGH PERFORMANCE	CONVENTIONAL
BOMBARDIER-SKI-DOO (Continued)						
400cc	Everest 400	1975	ETX18L{64}	YTX24HL-BS{64}	Y50-N18L-A-LM	Y50-N18L-A
	TNT 400	1974-70	ETX18L{64}	YTX24HL-BS{64}	Y50-N18L-A-LM	Y50-N18L-A
380cc	Citation 4500	1983-80	ETX18L{64}	YTX24HL-BS{64}	Y50-N18L-A-LM	Y50-N18L-A
	Formula 380	2001-94	ETX18L{64}	YTX24HL-BS{64}	Y50-N18L-A-LM	Y50-N18L-A
	Formula 380	1990-85	ETX18L{64}	YTX24HL-BS{64}	Y50-N18L-A-LM	Y50-N18L-A
	GSX, GTX 380	2006	ETX18L{64}	YTX24HL-BS{64}	Y50-N18L-A-LM	Y50-N18L-A
	Grand Touring 380	2003-95	ETX18L{64}	YTX24HL-BS{64}	Y50-N18L-A-LM	Y50-N18L-A
	Legend 380	2004-02	ETX18L{64}	YTX24HL-BS{64}	Y50-N18L-A-LM	Y50-N18L-A
	Nordik	1983-82	ETX18L{64}	YTX24HL-BS{64}	Y50-N18L-A-LM	Y50-N18L-A
	Safari, Skandic	2000-82	ETX18L{64}	YTX24HL-BS{64}	Y50-N18L-A-LM	Y50-N18L-A
340cc	All Models	1980-70	ETX18L{64}	YTX24HL-BS{64}	Y50-N18L-A-LM	Y50-N18L-A
300cc	All Models	1979-70	ETX18L{64}	YTX24HL-BS{64}	Y50-N18L-A-LM	Y50-N18L-A
	Freestyle	2006	ETX18L{64}	YTX24HL-BS{64}	Y50-N18L-A-LM	Y50-N18L-A
	Tundra	2006-03	ETX18L{64}	YTX24HL-BS{64}	Y50-N18L-A-LM	Y50-N18L-A
270cc	All Models	2004-86	ETX18L{64}	YTX24HL-BS{64}	Y50-N18L-A-LM	Y50-N18L-A
	All Models	1983	ETX18L{64}	YTX24HL-BS{64}	Y50-N18L-A-LM	Y50-N18L-A
	All Models	1981	ETX18L{64}	YTX24HL-BS{64}	Y50-N18L-A-LM	Y50-N18L-A
250cc	All Models	1996-81	ETX18L{64}	YTX24HL-BS{64}	Y50-N18L-A-LM	Y50-N18L-A
	All Models	1979-75	ETX18L{64}	YTX24HL-BS{64}	Y50-N18L-A-LM	Y50-N18L-A
All	ZX Types	2007-02	ETX20L	YTX20L-BS	---	---
	ZX Types	2001-99	---	YTX15L-BS	---	---
	ZX Types	1998-94	ETX18L{64}	YTX24HL-BS{64}	Y50-N18L-A-LM	Y50-N18L-A
KAWASAKI						
550cc	All Models	1982	ETX18L{64}	YTX24HL-BS{64}	Y50-N18L-A-LM	Y50-N18L-A
440cc	All Models	1982-77	ETX18L{64}	YTX24HL-BS{64}	Y50-N18L-A-LM	Y50-N18L-A
340cc	All Models	1981-77	ETX18L{64}	YTX24HL-BS{64}	Y50-N18L-A-LM	Y50-N18L-A
POLARIS						
900cc	900 Fusion, Switchback	2006-05	ETX15{122}	YTX14AH-BS{72}	YB14A-A2	---
	900 RMK	2006-05	ETX15{122}	YTX14AH-BS{72}	YB14A-A2	---
800cc	Indy 800,Classic,Touring, XC	2005-94	ETX15{122}	YTX14AH-BS{72}	YB14A-A2	---
750cc	FS,FST	2006	ETX20L	YTX20L-BS	---	---
	Indy Storm	1993	ETX15{122}	YTX14AH-BS{72}	YB14A-A2	---
700cc	Indy Classic,Touring, XC	2006-96	ETX15{122}	YTX14AH-BS{72}	YB14A-A2	---
650cc	Indy 650	1992	ETX15{122}	YTX14AH-BS{72}	YB14A-A2	---
	Indy,RXL	1997-92	---	---	YB9A-A	---
	Indy,Trail, Widetrack	1991-88	ETX18L{64}	YTX24HL-BS{64}	Y50-N18L-A-LM	Y50-N18L-A
600cc	Indy Classic,Touring, XC	2006-93	ETX15{122}	YTX14AH-BS{72}	YB14A-A2	---
	Indy,RXL	1996	---	---	YB9A-A	---
	Indy,Trail, Widetrack	1987-82	ETX18L{64}	YTX24HL-BS{64}	Y50-N18L-A-LM	Y50-N18L-A
550cc	Indy 550, Classic,Sport,Touring	2006-99	ETX15{122}	YTX14AH-BS{72}	YB14A-A2	---
500cc	500 Classic	2006-01	ETX15{122}	YTX14AH-BS{72}	YB14A-A2	---
	500 Edge	2004	ETX15{122}	YTX14AH-BS{72}	YB14A-A2	---
	500 XC	2006-99	ETX15{122}	YTX14AH-BS{72}	YB14A-A2	---
	Centurion	1980	ETX15{122}	YTX14AH-BS{72}	YB14A-A2	---
	Indy 500,Classic	2006-92	ETX15{122}	YTX14AH-BS{72}	YB14A-A2	---
	Indy,RXL	1997-92	---	---	YB9A-A	---
	Indy,Trail, Widetrack	2006-86	ETX18L{64}	YTX24HL-BS{64}	Y50-N18L-A-LM	Y50-N18L-A
440cc	440 Pro X	2005-04	ETX15{122}	YTX14AH-BS{72}	YB14A-A2	---
	Galaxy 440	1980	ETX15{122}	YTX14AH-BS{72}	YB14A-A2	---
	Indy,Sport,Trail,Transport	2003-92	ETX15{122}	YTX14AH-BS{72}	YB14A-A2	---
	Indy,Trail, Widetrack	1991	ETX18L{64}	YTX24HL-BS{64}	Y50-N18L-A-LM	Y50-N18L-A
	Indy,Trail, Widetrack	1989-82	ETX18L{64}	YTX24HL-BS{64}	Y50-N18L-A-LM	Y50-N18L-A
	Sprint,Star	1985	ETX16{120}	---	Y60-N24-A	---
400cc	Indy,Trail, Widetrack	1991-85	ETX18L{64}	YTX24HL-BS{64}	Y50-N18L-A-LM	Y50-N18L-A
340cc	340 Classic,Edge,Touring	2006-03	ETX15{122}	YTX14AH-BS{72}	YB14A-A2	---
	Apollo	1980	ETX15{122}	YTX14AH-BS{72}	YB14A-A2	---
	Galaxy 340	1980	ETX15{122}	YTX14AH-BS{72}	YB14A-A2	---

{64} Top and front terminal mounts only. {72} Includes 10mm spacer for additional height required in replacing YB14A-A1 and YB14A-A2.

{75} Shipped with 17mm adapter. {120} Shipped with 20mm adapter. Hold-down modifications may be necessary.

{122} Shipped with 10mm adapter.Hold-down modifications may be necessary.

CC	MODEL	YEAR	PREMIUM AGM Activated/ Ready to-install	STANDARD DRY		
				STANDARD AGM	LOW MAINTENANCE-HIGH PERFORMANCE	CONVENTIONAL
POLARIS (Continued)						
340cc	Indy,Indy Lite	2003-92	ETX15{122}	YTX14AH-BS{72}	YB14A-A2	---
	Indy,Trail, Widetrack	1991-88	ETX18L{64}	YTX24HL-BS{64}	Y50-N18L-A-LM	Y50-N18L-A
	Indy,Trail, Widetrack	1983-82	ETX18L{64}	YTX24HL-BS{64}	Y50-N18L-A-LM	Y50-N18L-A
	Sprint,Star	1990-86	ETX16{120}	---	Y60-N24-A	---
	TX,C,L	1980	ETX18L{64}	YTX24HL-BS{64}	Y50-N18L-A-LM	Y50-N18L-A
250cc	Gemini 250	1980	ETX15{122}	YTX14AH-BS{72}	YB14A-A2	---
	Indy StarLite	1995-92	ETX15{122}	YTX14AH-BS{72}	YB14A-A2	---
	Indy,Trail, Widetrack	1991	ETX18L{64}	YTX24HL-BS{64}	Y50-N18L-A-LM	Y50-N18L-A
	Sprint,Star	1984-82	ETX16{120}	---	Y60-N24-A	---
120cc	120 Pro X	2006	ETX20L	YTX20L-BS	---	---
	120 Pro X	2005-04	ETX15{122}	YTX14AH-BS{72}	YB14A-A2	---
	Indy 120	2003-00	ETX15{122}	YTX14AH-BS{72}	YB14A-A2	---
SCORPION						
440cc	Sting 440	1980	ETX15L	YTX14AHL-BS	YB14L-A2	12N14-3A
	Whip 440	1980	ETX15L	YTX14AHL-BS	YB14L-A2	12N14-3A
400cc	Sting 400	1980	ETX15L	YTX14AHL-BS	YB14L-A2	12N14-3A
340cc	Whip 340	1980	ETX15L	YTX14AHL-BS	YB14L-A2	12N14-3A
290cc	Lil' Whip	1980	ETX15L	YTX14AHL-BS	YB14L-A2	12N14-3A
YAMAHA						
1000cc	Apex	2008-06	ETX14{75}	YTX14-BS	---	---
	Attak	2006	ETX16L{120}	YTX20L-BS	YB16L-B	12N16-3B
	Nytro	2006	ETX16L{120}	YTX20L-BS	YB16L-B	12N16-3B
	RS Rage,Vector,Venture	2006	ETX16L{120}	YTX20L-BS	YB16L-B	12N16-3B
	RS Rage,Vector,Venture	2005	ETX20L	YTX20L-BS	---	---
	RX1000R, RX	2005-03	ETX20L	YTX20L-BS	---	---
	VK Professional	2006	ETX16L{120}	YTX20L-BS	YB16L-B	12N16-3B
800cc	Mountain Max 800	1997	ETX18L{64}	YTX24HL-BS{64}	Y50-N18L-A-LM	Y50-N18L-A
	VX800 V-Max	1996-95	ETX18L{64}	YTX24HL-BS{64}	Y50-N18L-A-LM	Y50-N18L-A
750cc	VX750 V-Max	1998-92	ETX18L{64}	YTX24HL-BS{64}	Y50-N18L-A-LM	Y50-N18L-A
700cc	Mountain Max 700	2004-97	ETX18L{64}	YTX24HL-BS{64}	Y50-N18L-A-LM	Y50-N18L-A
	SX,SXV	2006-98	ETX18L{64}	YTX24HL-BS{64}	Y50-N18L-A-LM	Y50-N18L-A
	VT700 Venture	2004-98	ETX18L{64}	YTX24HL-BS{64}	Y50-N18L-A-LM	Y50-N18L-A
	VX700 V-Max,DeLuxe	2002-98	ETX18L{64}	YTX24HL-BS{64}	Y50-N18L-A-LM	Y50-N18L-A
600cc	Mountain Max 600	2002-99	ETX18L{64}	YTX24HL-BS{64}	Y50-N18L-A-LM	Y50-N18L-A
	Mountain Max 600	1998-97	---	---	YB16AL-A2	---
	SRX600	1999	ETX18L{64}	YTX24HL-BS{64}	Y50-N18L-A-LM	Y50-N18L-A
	SRX600	1998	---	---	YB16AL-A2	---
	SX,SXV	2006-00	ETX18L{64}	YTX24HL-BS{64}	Y50-N18L-A-LM	Y50-N18L-A
	VT600 Venture	2006-99	ETX18L{64}	YTX24HL-BS{64}	Y50-N18L-A-LM	Y50-N18L-A
	VT600 Venture	1998-97	---	---	YB16AL-A2	---
	VX600 V-Max	2003-99	ETX18L{64}	YTX24HL-BS{64}	Y50-N18L-A-LM	Y50-N18L-A
	VX600 V-Max,LE,DX,ST,XT	1998-94	---	---	YB16AL-A2	---
570cc	EX570 Exciter, II	1993-87	---	---	YB16AL-A2	---
535cc	Excel V	1980	ETX18L{64}	YTX24HL-BS{64}	Y50-N18L-A-LM	Y50-N18L-A
	SRV 540	1991-82	---	---	YB16AL-A2	---
	SRV 540	1981-80	ETX15L	YTX14AHL-BS	YB14L-A2	12N14-3A
	VK540E II,III	2005-83	---	---	YB16AL-A2	---
	XL540 XLV	1990-85	---	---	YB16AL-A2	---
500cc	SX,SXV	2001-00	ETX18L{64}	YTX24HL-BS{64}	Y50-N18L-A-LM	Y50-N18L-A
	SX,SXV	1982	---	---	YB16AL-A2	---
	VT500 Venture	2001-97	---	---	YB16AL-A2	---
	VX500 V-Max	2001-94	---	---	YB16AL-A2	---
485cc	PZ480E Phazer Deluxe,LE,S,II	1998-84	ETX15L	YTX14AHL-BS	YB14L-A2	12N14-3A
	PZ500 Phazer	2001-98	---	---	YB16AL-A2	---
	VT480 VentureGT, XL	1998-91	ETX15L	YTX14AHL-BS	YB14L-A2	12N14-3A
440cc	Enticer 440	1980	ETX15L	YTX14AHL-BS	YB14L-A2	12N14-3A
	Exciter 440	1981	ETX15L	YTX14AHL-BS	YB14L-A2	12N14-3A
	Exciter 440	1976	ETX18L{64}	YTX24HL-BS{64}	Y50-N18L-A-LM	Y50-N18L-A

SNOWMOBILES

CC	MODEL	YEAR	PREMIUM AGM Activated/ Ready to-install	STANDARD DRY		
				STANDARD AGM	LOW MAINTENANCE- HIGH PERFORMANCE	CONVENTIONAL
YAMAHA (Continued)						
440cc	GP440	1977-76	ETX18L{64}	YTX24HL-BS{64}	Y50-N18L-A-LM	Y50-N18L-A
	Prestige 440	1976	ETX18L{64}	YTX24HL-BS{64}	Y50-N18L-A-LM	Y50-N18L-A
	SS,SRX	1981-80	ETX15L	YTX14AHL-BS	YB14L-A2	12N14-3A
	SS,SRX	1979-76	ETX18L{64}	YTX24HL-BS{64}	Y50-N18L-A-LM	Y50-N18L-A
410cc	ET410TR Enticer	2004-02	ETX18L{64}	YTX24HL-BS{64}	Y50-N18L-A-LM	Y50-N18L-A
	ET410TR Enticer	1995-89	ETX18L{64}	YTX24HL-BS{64}	Y50-N18L-A-LM	Y50-N18L-A
340cc	CS340 Ovation	1999-89	ETX15L	YTX14AHL-BS	YB14L-A2	12N14-3A
	EC340E	1981	ETX15L	YTX14AHL-BS	YB14L-A2	12N14-3A
	ET340 Enticer	1988-82	ETX15L	YTX14AHL-BS	YB14L-A2	12N14-3A
	ET340 Enticer	1980	ETX15L	YTX14AHL-BS	YB14L-A2	12N14-3A
	ET340 Enticer	1979	ETX18L{64}	YTX24HL-BS{64}	Y50-N18L-A-LM	Y50-N18L-A
	ET340 Enticer	1978	ETX15L	YTX14AHL-BS	YB14L-A2	12N14-3A
	EX340 Excel, III	1988-83	ETX15L	YTX14AHL-BS	YB14L-A2	12N14-3A
	EX340 Excel, III	1979	ETX15L	YTX14AHL-BS	YB14L-A2	12N14-3A
	Exciter 340	1976	ETX18L{64}	YTX24HL-BS{64}	Y50-N18L-A-LM	Y50-N18L-A
	GS340	1977-76	ETX18L{64}	YTX24HL-BS{64}	Y50-N18L-A-LM	Y50-N18L-A
	SRX340	1976	ETX18L{64}	YTX24HL-BS{64}	Y50-N18L-A-LM	Y50-N18L-A
300cc	CF300 Inviter	1990-86	---	---	YB16AL-A2	---
	ET300 Enticer	1984-83	ETX15L	YTX14AHL-BS	YB14L-A2	12N14-3A
	ET300 Enticer	1981-80	ETX15L	YTX14AHL-BS	YB14L-A2	12N14-3A
	ET300 Enticer	1979	ETX18L{64}	YTX24HL-BS{64}	Y50-N18L-A-LM	Y50-N18L-A
	GP,GS,SM300	1977-75	ETX18L{64}	YTX24HL-BS{64}	Y50-N18L-A-LM	Y50-N18L-A
250cc	ET250	1981	ETX15L	YTX14AHL-BS	YB14L-A2	12N14-3A
	ET250	1979-77	ETX18L{64}	YTX24HL-BS{64}	Y50-N18L-A-LM	Y50-N18L-A
	Enticer 250	1980	ETX15L	YTX14AHL-BS	YB14L-A2	12N14-3A
125cc	SV125 Sno Sport	1991-90	ETX15L	YTX14AHL-BS	YB14L-A2	12N14-3A
80cc	SV80 Sno Scoot	1990-88	---	---	YB7L-B	12N7-3B

{61} Activated ready to install. {64} Top and front terminal mounts only. {76} Shipped with 10mm adapter.

APPLICATION DATA

SCOOTERS / MOPEDS

CC	MODEL	YEAR	PREMIUM AGM Activated/ Ready to-install	STANDARD DRY		
				STANDARD AGM	LOW MAINTENANCE- HIGH PERFORMANCE	CONVENTIONAL
HONDA						
600cc	FSC600	2007-02	---	YTZ12S{61}	---	---
250cc	CH250 Elite	1990-85	ETX12	YTX12-BS	---	---
	CN250 Helix	2007-86	ETX12	YTX12-BS	---	---
	NSS250	2007-01	---	YTZ12S{61}	---	---
	PS250 Big Ruckus	2006-05	---	YTZ12S{61}	---	---
150cc	CH150 Elite	1987	ETX9	YTX9-BS	---	---
	CH150 Elite	1986-85	---	---	YB9-B	12N9-4B-1
125cc	CH125 Elite	1984	---	---	YB9-B	12N9-4B-1
	NH125 Aero	1984	---	---	YB5L-B	12N5-3B
80cc	CH80 Elite	2007-85	---	YTX5L-BS	---	---
	NH80 Aero	1985	---	YTX5L-BS	---	---
	NH80MD Aero	1984-83	---	---	YB5L-B	12N5-3B
50cc	CHF50 Metropolitan	2007-02	---	YTZ7S{61}	---	---
	MB50MD Aero	1983	---	---	YB2.5L-C	---
	NA50 Express II	1981-80	---	---	---	6N4-2A-8
	NA50 Express II	1979	---	---	---	6N2-2A
	NB50 Aero	1987-85	---	YTX4L-BS	---	---
	NB50M Aero	1984-83	---	---	YB4L-B	---
	NC50 Express	1983-80	---	---	---	6N4-2A-8
	NC50 Express	1979-78	---	---	---	6N2-2A
	NC50 Express	1977	---	---	---	6N2A-2C-3
	NN50MD Gyro	1984	---	---	YB4L-B	---
	NPS50 Ruckus	2007-03	---	YTZ7S{61}	---	---
	NQ50 Spree	1987-86	---	YTX4L-BS	---	---
	NQ50 Spree	1985-84	---	---	YB4L-B	---
	PA50	1983-78	---	---	---	6N4B-2A-5
	SA,SB 50 Elite	2001-92	---	YTX4L-BS	---	---
	SA,SB 50 Elite	1990-87	---	YTX4L-BS	---	---
	TG50 Gyro	1986-85	---	YTX4L-BS	---	---
	ZB50	1988	---	YTX4L-BS	---	---
SUZUKI						
650cc	AN650 Burgman	2008-03	ETX15{76}	YTX14AH-BS	YB14-A2	---
400cc	AN400 Burgman	2007-03	---	YT12A-BS	---	---
50cc	F50MX	1981	---	---	---	6N4-2A
	FA50 Shuttle	1991-80	---	---	---	6N2-2A-4
	FS,FZ 50	1983-79	---	---	---	6N4-2A
YAMAHA						
400cc	YP400 Majesty	2007-04	---	YT9B-4{61}	---	---
250cc	Morphous	2007-06	---	YTZ10S{61}	---	---
200cc	XC200 Riva	1991-86	---	---	YB10L-B2	---
180cc	XC180 Riva	1985-83	---	---	YB10L-B	12N10-3B
125cc	XC125 Riva	2001-85	---	---	YB7C-A	---
	YJ125T Vino125	2007-04	---	YTX7A-BS	---	---
80cc	CV80 Riva	1987-83	---	---	6YB11-2D	6N11-2D
	LB80 Chappy	1978-76	---	---	---	6N4-2A-5
50cc	CA50 Riva	1986-83	---	---	---	6YB8L-B
	CE50 Jog	1988-86	---	---	YB4L-B	---
	CG50 Riva Jog	1991-88	---	---	YB4L-B	---
	CV50	1984	---	---	---	6YB8L-B
	CW50 Zuma, II	2001-97	---	---	YB4L-B	---
	CW50 Zuma, II	1990-88	---	---	YB4L-B	---
	CY50 Riva Jog	2001-91	---	YTX4L-BS	---	---
	LB50	1982-77	---	---	---	6N4-2A-5
	LC50 Champ	1981-80	---	---	---	6N4-2A-5
	LP50P Chappy	1982-81	---	---	---	6N4-2A-5
	MJ50J Towney	1982	---	---	---	6N4-2A-5
	QT50 Yamahopper	1988-79	---	---	---	6N4-2A-5
	RX50 50 Special	1984-83	---	---	---	6N4-2A-5

CC	MODEL	YEAR	PREMIUM AGM Activated/ Ready to-install	STANDARD DRY		
				STANDARD AGM	LOW MAINTENANCE- HIGH PERFORMANCE	CONVENTIONAL
YAMAHA (Continued)						
50cc	SH50 Riva Razz	2001-87	---	---	YB4L-B	---
	XC50 Vino Classic	2007-06	---	YTZ7S	YTX5L-BS	---
	XF50W	2007	---	YTX5L-BS	---	---
	YJ50	2003-01	---	YT4B-BS	---	---
	YW50A Zuma	2003-02	---	YTX5L-BS	---	---

{61} Activated ready to install. {64} Top and front terminal mounts only.

{71} Height with 20mm spacer included for use in replacing YB16CL-B.

{72} Includes 10mm spacer for additional height required in replacing YB14A-A1 and YB14A-A2.

{77} Does not meet Harley-Davidson OEM specifications.

{120} Shipped with 20mm adapter. Hold-down modifications may be necessary.

{122} Shipped with 10mm adapter. Hold-down modifications may be necessary.

APPLICATION DATA

UTILITY VEHICLES

CC	MODEL	YEAR	PREMIUM AGM Activated/ Ready to-install	STANDARD DRY		
				STANDARD AGM	LOW MAINTENANCE- HIGH PERFORMANCE	CONVENTIONAL
ARCTIC CAT						
650cc	Prowler	2007-06	ETX18L{64}	YTX24HL-BS{64}	Y50-N18L-A-LM	Y50-N18L-A
KAWASAKI						
950cc	KAF950 Mule	2007-06	NA	---	---	---
750cc	Teryx	2008	NA	---	---	---
620cc	KAF620 Mule 2500,2510,2520	2000-98	ETX16L{120}	YTX20HL-BS-PW{71}	YB16CL-B	---
	KAF620 Mule 2500,2510,2520	1996-93	ETX16L{120}	YTX20HL-BS-PW{71}	YB16CL-B	---
	KAF620 Mule 3000, 3010,3020	2007-01	ETX20L	YTX20L-BS	---	---
610cc	KAF610 Mule Camo	2007	NA	---	---	---
540cc	KAF540 Mule 2010,2020,2030	1993-91	ETX16L{120}	YTX20HL-BS-PW{71}	YB16CL-B	---
450cc	KAF450 Mule 1000	1996-91	ETX16L{120}	YTX20HL-BS-PW{71}	YB16CL-B	---
400cc	KAF400 Mule,600,610	2007-05	ETX15{122}	YTX14AH-BS{72}	YB14A-A2	---
300cc	KAF300 Mule 500	2001-91	ETX15{122}	YTX14AH-BS{72}	YB14A-A2	---
POLARIS						
800cc	RZR	2008	ETX20L	YTX20L-BS	---	---
700cc	Ranger	2008-06	ETX30L{77}	YIX30L{61}	YB30L-B	---
500cc	Ranger	2008-98	ETX30L{77}	YIX30L{61}	YB30L-B	---
425cc	Ranger	2003-02	ETX30L{77}	YIX30L{61}	YB30L-B	---
SUZUKI						
620cc	QUV620F	2005	ETX20L	YTX20L-BS	---	---
YAMAHA						
650cc	Rhino 650	2007	NA	---	---	---
450cc	Rhino 450	2007	NA	---	---	---

RIDING MOWERS

APPLICATION DATA

CC	MODEL	YEAR	PREMIUM AGM Activated/ Ready to-install	STANDARD DRY		
				STANDARD AGM	LOW MAINTENANCE- HIGH PERFORMANCE	CONVENTIONAL
ALLIS-CHALMERS						
	405,508		---	---	YB9-B	12N9-4B-1
ARIENS/GRAVELY CO.						
	1330,1332,8028,8530		ETX15{122}	YTX14AH-BS{72}	YB14A-A2	---
	901000,925000,927000 Series		---	---	YB12A-A	12N12A-4A-1
ATLAS TOOL & MFG. CO.						
	ER2600,2650,2680,3280		---	---	---	12N9-3A
	ER2600,2650,2680,3281		---	---	---	12N9-3A
	ER2600,2650,2680,3282		---	---	---	12N9-3A
	ER2600,2650,2680,3283		---	---	---	12N9-3A
BOLENS						
	Husky 728,770,830		---	---	YB9-B	12N9-4B-1
	Husky 728,770,831		---	---	YB9-B	12N9-4B-1
	Husky 728,770,832		---	---	YB9-B	12N9-4B-1
CARTER BROTHERS						
	EZ-502,C,702,702C		---	---	YB12A-A	12N12A-4A-1
CASE INTERNATIONAL						
	M80		---	---	YB12A-A	12N12A-4A-1
GARDEN WAY/TROY BUILT						
	Pony (after 1996)		---	---	YB9-B	12N9-4B-1
	Pony (before 1996)		---	---	YB12A-A	12N12A-4A-1
GENERAL POWER						
	3-725-E7,8,9,FS		---	---	YB12A-A	12N12A-4A-1
HUFFMAN MFG. CO. (HUFFY)						
	H-270,360		---	---	YB12A-A	12N12A-4A-1
	H-270,361		---	---	YB12A-A	12N12A-4A-1
HULL INDUSTRIES						
	TC30ER		ETX16{120}	YTX20-BS{66}	YB16-B-LM	YB16-B
INGERSOL EQUIPMENT						
	80X Series	1993-84	---	---	YB12A-A	12N12A-4A-1
JACOBSEN/HOMELITE/HUSTLER						
	42642,43020,43032,43037,43043		---	---	YB9-B	12N9-4B-1
	Javelin MK11		---	---	YB9-B	12N9-4B-1
	RE-8E		---	---	YB9-B	12N9-4B-1
LAWN BOY						
	8233E,333,335,5802,5803,7258E,7259E, 7260E,8228E,8229E		---	---	---	12N9-3A
MONTGOMERY WARD						
	99 & Under Series		---	---	YB9-B	12N9-4B-1
MTD PRODUCTS						
	300 Series		ETX15L	YTX14AHL-BS	YB14L-A2	12N14-3A
	400 Series		ETX15L	YTX14AHL-BS	YB14L-A2	12N14-3A
	500 Series		ETX15L	YTX14AHL-BS	YB14L-A2	12N14-3A
	600 Series		ETX15L	YTX14AHL-BS	YB14L-A2	12N14-3A
	700 Series		ETX15L	YTX14AHL-BS	YB14L-A2	12N14-3A
	700 Series before 1981		ETX18L{64}	---	Y50-N18L-A-LM	---
	800 Series before 1981		ETX18L{64}	---	Y50-N18L-A-LM	---
MURRAY OHIO MFG. CO.						
	2523,3033,3035,6-30502,6-30702,7-30702		ETX15L	YTX14AHL-BS	YB14L-A2	12N14-3A
	2523,3033,3035,6-30502,6-30702,7-30703		ETX15L	YTX14AHL-BS	YB14L-A2	12N14-3A
	2523,3033,3035,6-30502,6-30702,7-30704		ETX15L	YTX14AHL-BS	YB14L-A2	12N14-3A
	2523,3033,3035,6-30502,6-30702,7-30705		ETX15L	YTX14AHL-BS	YB14L-A2	12N14-3A
	2523,3033,3035,6-30502,6-30702,7-30706		ETX15L	YTX14AHL-BS	YB14L-A2	12N14-3A
	2523,3033,3035,6-30502,6-30702,7-30707		ETX15L	YTX14AHL-BS	YB14L-A2	12N14-3A
	2523,3033,3035,6-30502,6-30702,7-30708		ETX15L	YTX14AHL-BS	YB14L-A2	12N14-3A
	2523,3033,3035,6-30502,6-30702,7-30709		ETX15L	YTX14AHL-BS	YB14L-A2	12N14-3A

{64} Top and front terminal mounts only. {66} The YTX20 series batteries may be used as an optional upgrade. See battery label for retrofit cautions.

{72} Includes 10mm spacer for additional height required in replacing YB14A-A1 and YB14A-A2.

{120} Shipped with 20mm adapter. Hold-down modifications may be necessary. {122} Shipped with 10mm adapter. Hold-down modifications may be necessary.

APPLICATION DATA

RIDING MOWERS

CC	MODEL	YEAR	PREMIUM AGM Activated/ Ready to-install	STANDARD DRY		
				STANDARD AGM	LOW MAINTENANCE- HIGH PERFORMANCE	CONVENTIONAL
NOMA						
	321050 Series		ETX15L	YTX14AHL-BS	YB14L-A2	12N14-3A
	328000 Series		ETX15L	YTX14AHL-BS	YB14L-A2	12N14-3A
	36010 Series		ETX15L	YTX14AHL-BS	YB14L-A2	12N14-3A
ROPER						
	96444,96927,96941,K522,K852, K922 Series,K932Series, L8000AT		ETX15L	YTX14AHL-BS	YB14L-A2	12N14-3A
SEARS						
	131.96927,131.96941,131.96970,131.969310		---	---	---	12N9-3A
	502.256050,51,60,63,70,71,80,81		ETX15L	YTX14AHL-BS	YB14L-A2	12N14-3A
	502.256120,26,30,32,34,36,38		ETX15L	YTX14AHL-BS	YB14L-A2	12N14-3A
	502.256135,36,37,40,41,42		ETX16L{120}	YTX20L-BS	YB16L-B	12N16-3B
	536.250820,23,70		---	---	---	12N9-3A
	536.250920,22		---	---	---	12N9-3A
	536.255110,12,13;536.255212,20,21,30,32,40,50		---	---	---	12N9-3A
	536.657020,40,60,80		---	---	---	12N9-3A
	536.658080536.963100		---	---	---	12N9-3A
	917.250740		---	---	---	12N9-3A
	917.255120,121		---	---	---	12N9-3A
	917.255260,70,73,917.255330,40		ETX15L	YTX14AHL-BS	YB14L-A2	12N14-3A
	917.259180,917.259320		---	---	---	12N9-3A
SIMPLICITY						
	3008,99075		---	---	YB9-B	12N9-4B-1
SNAPPER						
	All Walk Behind Mowers (Electric Start)		---	YTX4L-BS	---	---
SWISHER						
	18 Hp/32		---	---	YB12A-A	12N12A-4A-1
WESTERN INT'L. (DYNAMARK)						
	320000 Series,360000 Series		ETX15L	YTX14AHL-BS	YB14L-A2	12N14-3A
	421101		ETX15L	YTX14AHL-BS	YB14L-A2	12N14-3A
	456301		ETX15L	YTX14AHL-BS	YB14L-A2	12N14-3A
WHEEL HORSE/TORO						
	108-3.5,111-5,A115,A85	1985-84	ETX15L	YTX14AHL-BS	YB14L-A2	12N14-3A
WHITE OUTDOOR PRODUCTS						
	FST-16,GT -205,1000,185,,LT-125,155,160,165	1984	ETX18L{64}	---	Y50-N18L-A-LM	---
YARD MAN, INC.						
	13420,3730		---	---	---	12N9-3A
	Beetle & Yard Bug		ETX15L	YTX14AHL-BS	YB14L-A2	12N14-3A

12 VOLT IMPORT SPECIALTY BATTERY SPECIFICATION DATA

Type	Old Reference Number (Discontinued)	Plate/Cell	Cap. AH ▲ (5 hr)	Cap. AH ▲ (20 hr)	Crank Perform ▲ (A 0°F)	Res. Cap. Min. (80°F)	Overall Dimensions			Ship. Wt. Dry (lbs.)	Vol. of Acid (oz.)	Charging Current (Amp)	See Key For	
							L (inches)	W (inches)	H (inches)				Term.	Layout
40B19L(S)	36B20L(S)	9	28	35	275	52	7 $\frac{3}{4}$	5 $\frac{1}{8}$	8 $\frac{1}{8}$	16.5	84.6	3.5	A	2
32A19RT(S)	NX60-N24T(S)	11	24	30	320	42	7 $\frac{5}{8}$	4 $\frac{1}{8}$	7 $\frac{3}{8}$	12.4	64.0	3.0	A	1
32A19L	NX60-N24L	11	24	30	320	42	7 $\frac{3}{8}$	5	7 $\frac{1}{4}$	11.5	63.5	3.0	C	2
46B24R	NS60	13	36	45	330	75	9 $\frac{3}{8}$	5 $\frac{1}{8}$	8 $\frac{1}{8}$	19.8	109.3	4.5	B	1
46B24L(S)	NS60L(S)	13	36	45	330	75	9 $\frac{3}{8}$	5 $\frac{1}{8}$	8 $\frac{1}{8}$	19.8	109.3	4.5	A	2
40B19L	SY-B19L	9	28	35	275	52	7 $\frac{3}{4}$	5 $\frac{1}{8}$	8 $\frac{1}{8}$	14.1	91.7	3.5	B	2
55B24L(S)	NX100S6L(S)	13	36	45	410	70	9 $\frac{3}{8}$	5 $\frac{1}{8}$	8 $\frac{1}{8}$	19.8	109.3	4.5	A	2
115F51	N120	21	96	120	638	240	19 $\frac{3}{8}$	7 $\frac{3}{8}$	10 $\frac{3}{8}$	46.3	317.4	12.0	A	3
145F51	NS150	25	120	150	760	296	20	8 $\frac{3}{4}$	10 $\frac{3}{8}$	56.2	370.3	14.0	A	3

▲ Figures are based on JIS/SAE specifications and reference only

TERMINALS

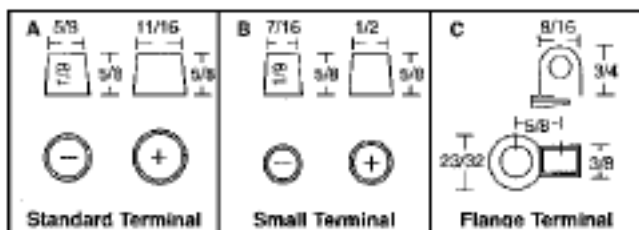

BATTERY LAYOUTS

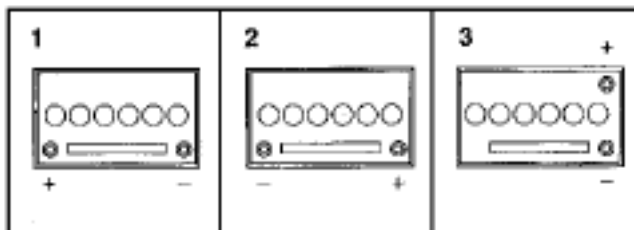

APPLICATION DATA

MODEL	BATTERY
HONDA	
EMS4000 (Generator)	32A19RT(S)
EMS4500 (Generator)	32A19RT (S)
ES6000 (Generator)	32A19RT (S)
ES6500 (Generator)	32A19L
EX4000 (Generator)	YB18L-A
EX4500 (Generator)	YB18L-A
EX5000 (Generator)	32A19RT (S)
EX5500 (Generator)	32A19RT (S)
H3011	32A19RT (S)
H4013, H4514H	32A19RT (S)
H5013, H5518	32A19RT (S)
H6522	55B24L (S)
HT3810, HT3813	32A19RT (S)
ISEKI	
TU1400, TU1500	46B24R
TU1600, TU1700	46B24R
TU1900, TU2100	46B24R
TX1000, TX1210	46B24R
TX1300, TX1410	46B24R
TX1500, TX1510	46B24R
KAWASAKI	
GD700-A52-700C	YT4L-BS
GE5000-ASI 5000cc	40B19L (S)
KUBOTA	
ADT70S (Tiller)	YB14-A2
B1550, B1750	55B24L (S)
B20, B2150, B4200	55B24L (S)

JAPANESE TRACTOR

MODEL	BATTERY
KUBOTA (continued)	
B5100	40B19L (S)
B5200	55B24L (S)
B6100	46B24L (S)
B6200, B7100	55B24L (S)
B7200	46B24L (S)
F150S, F260S, F300S	46B24L (S)
G1800, G1900	55B24L (S)
G3200, G4200, G5200	40B19L (S)
T1600	40B19L (S)
T1640	55B24L (S)
T1700X	40B19L (S)
MITSUBISHI	
D1500, D2000	46B24R
D2300, D2350	46B24R
D2600, D2650	46B24R
D3250	46B24R
M1301	46B24R
NS60	46B24R
S630	46B24R
ST1500, ST1510	46B24R
ST1520, ST1550	46B24R
ST2001, ST2300	46B24R
YANMAR	
Generator	32A19RT(S)
YM122, YM146	46B24R
YM155, YM165	40B19L
YM180D, YM187	46B24R

Batteries are Recyclable!

Imagine the environmental damage that can be caused by carelessly discarding 18 pounds of lead, two pounds of plastic, and a gallon of acid: the contents of a lead-acid battery. Now imagine that damage compounded by 75,000,000: the approximate number of lead-acid batteries available for recycling each year in the United States.

Fortunately, used lead-acid batteries can be safely recycled. In fact, they have been recycled since the 1920s, and today these batteries have a

higher recycling rate than other waste products such as aluminum, paper, and beverage containers made of glass or plastic, just to name a few. Over 98% of all used batteries are recycled today.

This is an EPA-permitted recycling system, which is important for you to know because hazardous disposal laws place heavy penalties on offenders and considerable paperwork burden on everyone. You can be assured that your scrap is being recycled in an environmentally safe manner.

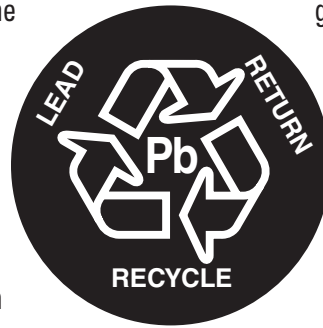

Scrap lead-acid batteries are disassembled in a ventilated battery breaker, where the lead, plastic and acid are safely separated.



The lead is processed and smelted in the reverberatory furnace, producing metal which goes to the refinery. There it is placed in kettles, combined with reagents, and alloyed into lead for use in new batteries.

The recycled plastic from the battery cases and covers is reclaimed in the plastic recovery plant, where it is cleaned and separated into polypropylene and lead-bearing materials. Polypropylene is recycled to make cases and covers for new batteries and other plastic products.



Battery acid is recycled in a patented acid reclamation plant. This one-of-a-kind, computer-controlled facility allows recycling of used battery acid for use in the production of new batteries. Tests show no difference in the performance of batteries using recycled sulfuric acid when compared to batteries using new acid.



Premium AGM Power Sports Batteries

Premium quality, specially designed Absorbed Glass Mat (AGM) batteries are manufactured under strict quality controls to assure superior performance and long life.

The AGM design allows easy installation without the worry of acid spills and damage to equipment.

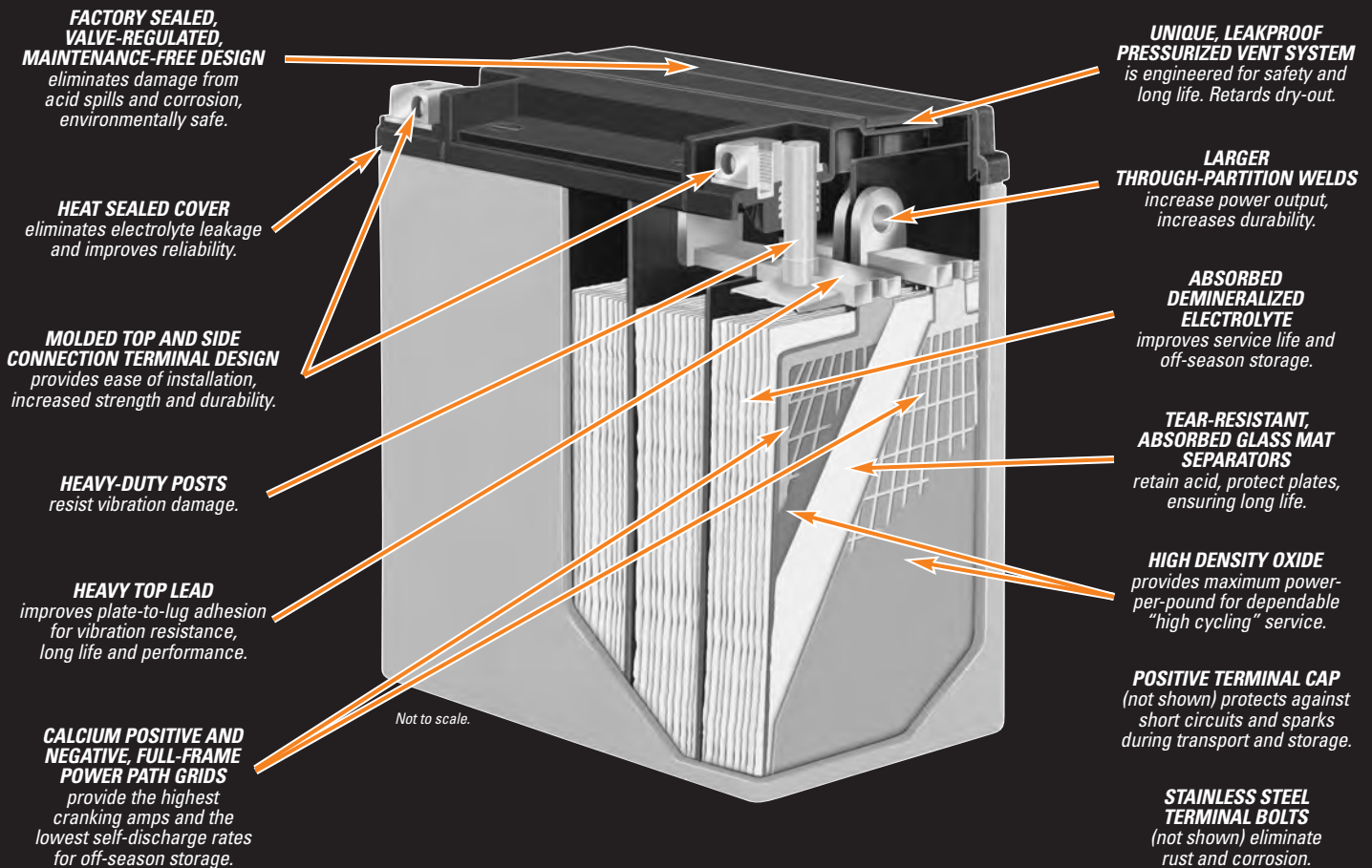

PROUDLY MANUFACTURED IN THE U.S.A.